



Low Harmonics Regenerative Matrix Converter U1000

U



Matrix Innovation

Certified for
ISO9001 and
ISO14001



JQA-0422 JQA-EM0498

Much More Than an AC Drive! Next-generation Motor Drives

Do You Have Problems with AC Drives?

Yaskawa's development of the world's first application of matrix converter technology in 2006 made it possible to solve AC drive problems. Further evolution of this technology has resulted in the U1000.

This sophisticated series of motor drives available only from Yaskawa eliminates the problems of standard AC drives. The U1000 tops the performance of general-purpose AC drives to further improve the performance of your facilities.



Matrix Innovation

[What Is a Matrix Converter?]

A matrix converter is AC/AC converter which consists of 9 bi-directional switches that are arranged in a matrix. It converts a three-phase AC power supply directly into the required voltage and frequency.

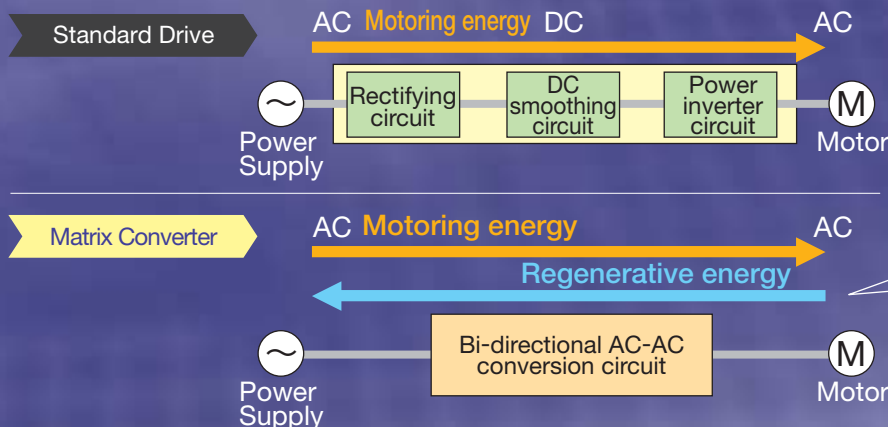
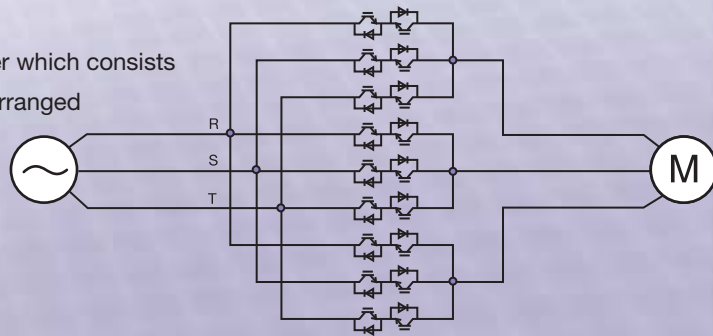

No main circuit capacitor

Special power module

Reuse the Previously Wasted Energy with a New Way to Save Energy

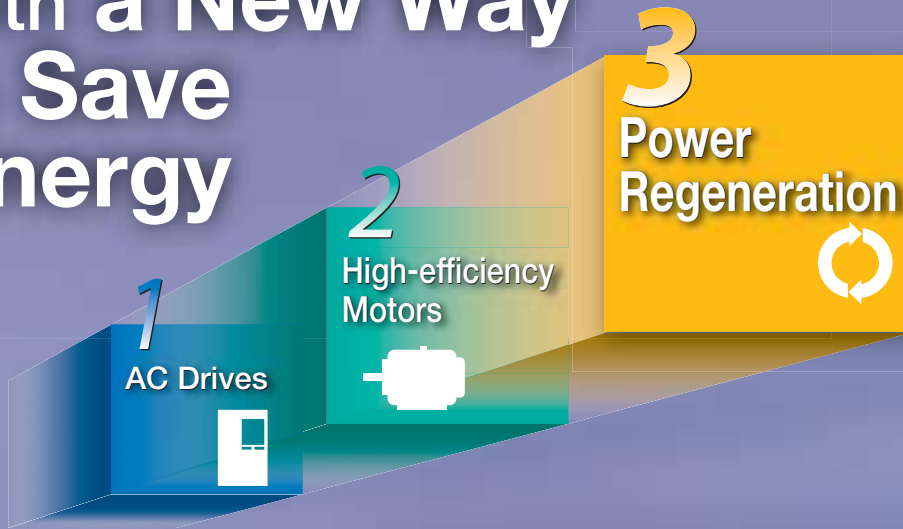

Low Harmonics The Pursuit of Power Quality!

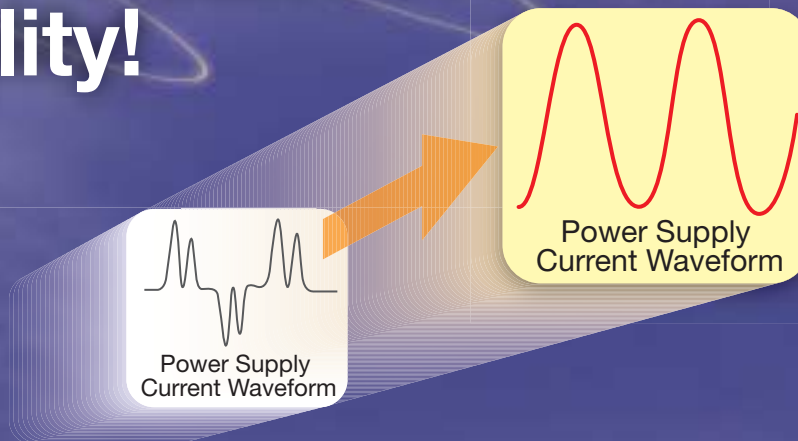

Compact All-in-One Unit!

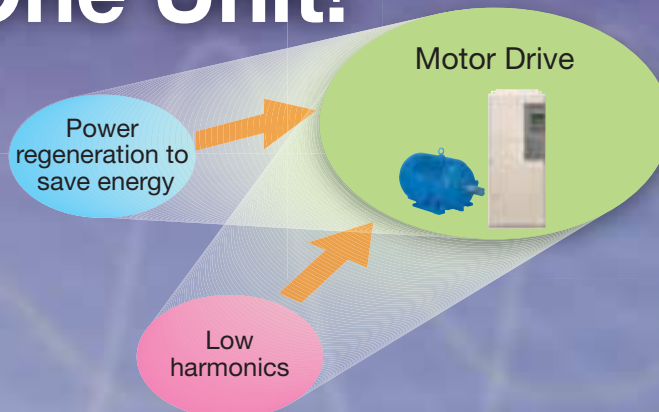

CONTENTS

Features	4
Product Lineup	12
Model Selection	13
Parameter List	14
Basic Instructions	20
Standard Specifications	22
Standard Connection Diagram	24
Dimensions	26
Fully-Enclosed Design	28
Peripheral Devices and Options	30
Application Notes	40
Global Service Network	45

Power Regeneration to Save Energy!



When a motor rotates, it consumes energy. When a motor is rotated, it generates energy. You can save energy by using regenerative energy instead of wasting it.

Regenerative Energy

■ Lifts, such as cranes

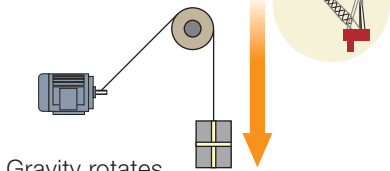

Gravity rotates the motor when the load is lowered.



■ Horizontal conveyors, such as dollies

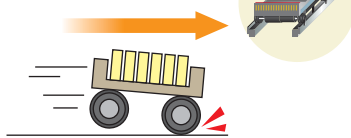

Inertia rotates the motor when the dolly decelerates or is stopped.



■ Generators, such as windmills and waterwheels



Wind, water, or another external force rotates a motor.



Efficient Energy Usage

Braking resistor results in discarding energy as heat, but you can return this regenerative energy to the power supply to save energy.

Braking Resistor Configuration

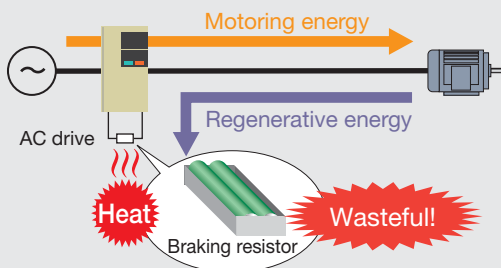

Matrix Converter U1000

Power regeneration is possible with just this one unit!



You Can Save This Much!

[Example of the Effectiveness of Regenerative Energy Savings]

■ Operation Cycle

10-t crane
16 m/min
Power cost: \$0.2/kWh

Regenerative energy is used as energy rather than discarding it as heat!

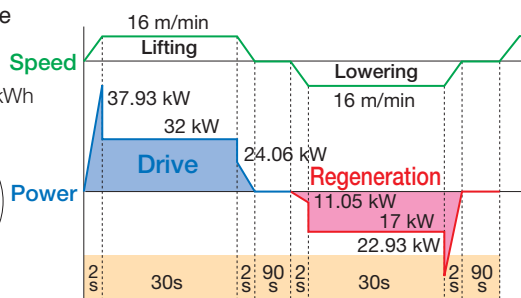

© Annual Power Consumption

Previous configuration : 10,150kWh

U1000 : 4,700kWh

Reduction
5,450kWh

© Annual Cost of Power

Previous configuration : \$2,030

U1000 : \$9,40

Reduction
\$1,090

Visualizing Savings in Electricity

Use analog outputs or communications networks to monitor all sorts of data with easy operations. You'll instantly see the energy that you've saved.

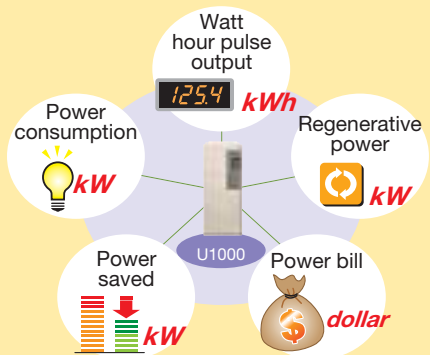

Low Harmonics!



Without peripheral devices, the input current waveform becomes sinusoidal, similar to that of a commercial power supply, so the harmonic pollution of the power supply is minimized for the protection of surrounding machinery. The available power system capacity can be increased, and the regulations on harmonics easily met.

Harmonics

When an AC drive converts power, the input current is distorted, which results in harmonics.

These harmonics can interfere with other electric devices, such as by causing overheating or damage to power supply facilities and malfunction and noise in precision devices.

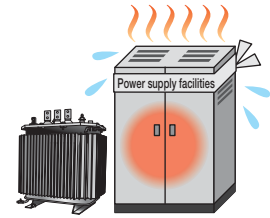

Conforms to IEEE519

Reduce power supply capacity

	Power Current Waveform Samples	Input Current Spectrums	Current Distortion	Power factor
AC drive without reactor			88%	0.75
AC drive with DC reactor			33%	0.9
Matrix Converter U1000			5%	0.98



Reduce Power Supply Capacity

The power factor is high, so you can use a lower power supply capacity.

You can also downsize wires and generator capacity, and may qualify for price benefits from your power company.

AC Drive
Power factor: Approx. **0.75**
(at rated current load)

U1000
Power factor: Approx. **0.98**
(at rated current load)

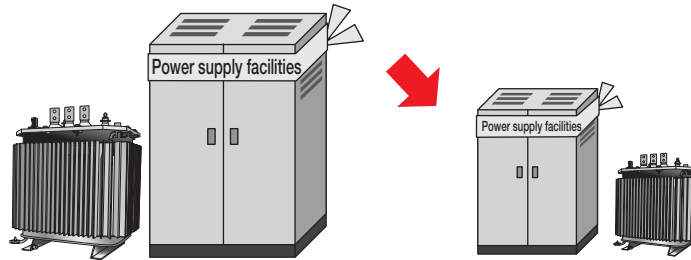

$$\text{Power usage (kW)} = \sqrt{3} \times V \times I \times \cos \theta$$

[active power] Power capacity(kVA) Power factor

Features

Product Lineup

Model Selection

Parameter List

Basic Instructions

Standard Specifications

Standard Connection Diagram

Dimensions

Fully-Enclosed Design

Peripheral Devices and Options

Application Notes

Global Service Network

Compact All-in-One Unit!



Compact

Harmonic countermeasures that were previously required to connect a converter, such as input AC reactors, harmonic filter reactors, and capacitors, are not necessary, which helps you save wiring, space, and energy costs.

Previous configuration

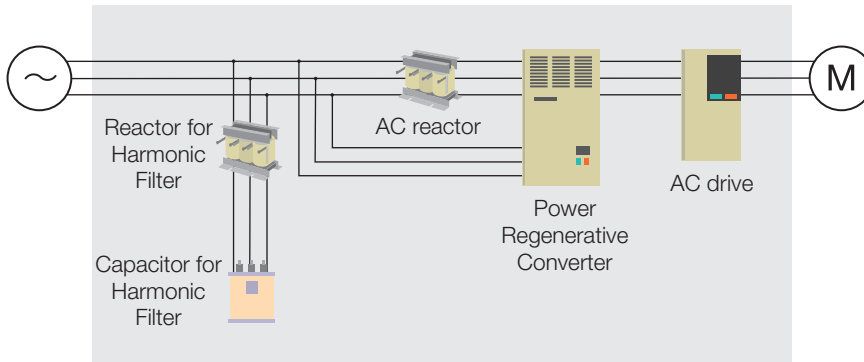

Wiring reduced
by approx. **70%**^{*1}
20 → 6

Footprint reduced
by approx. **65%**^{*1}

Weight reduced
by approx. **81%**^{*1}

19%
less power loss^{*2}

Just one unit!

Matrix Converter

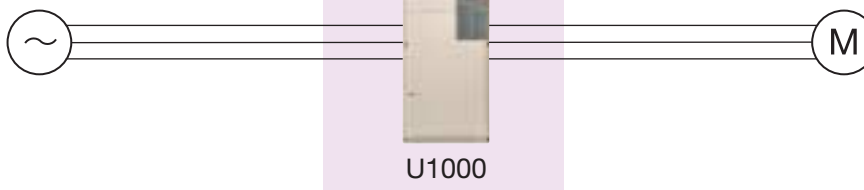

*1: Example for 400 V 30 kW
*2: Example for 400 V 15 kW



How's This for Compact!

[Control Panel Configuration Example] Unit : mm

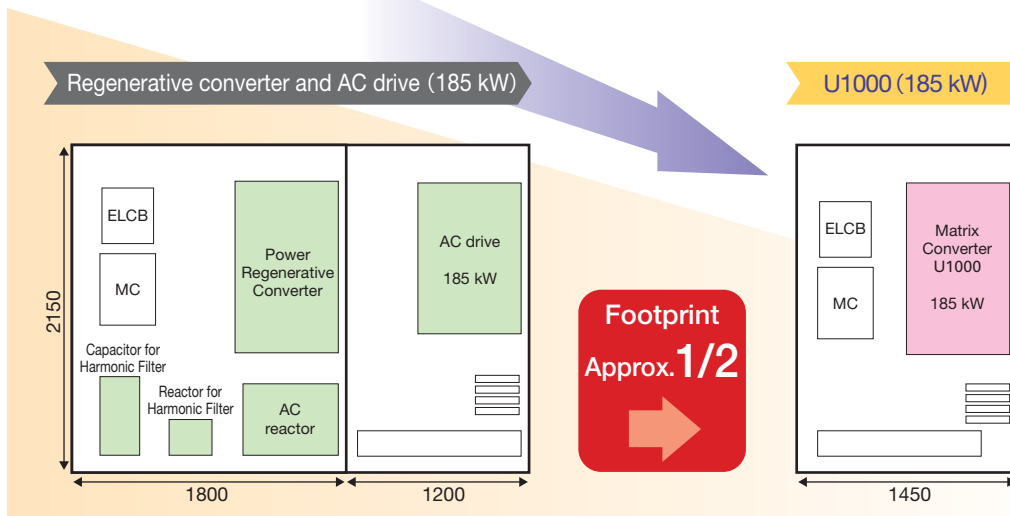

Even Better Than Previous Matrix Converters!

Drives Synchronous Motors

All types of motors can be controlled, including induction motors and IPM/SPM synchronous motors, without using sensors.

Greater Efficiency

Greater Efficiency

Greater Efficiency

Super power-saving motors

ECO iPM motors

ECOhIM motors

Standard efficiency

Ultra-high efficiency with high capacity

Unbelievable high-efficiency close to IE4

Premium-efficiency induction motors

General-purpose motors

Synchronous motors (with built-in permanent magnets)

Induction Motor

Wide Product Lineup

We've increased the number of 200-V-class models from 4 to 10 and the number of 400-V-class models from 7 to 23.

Compliance with SIL3 Safety Standard

SIL3 compliance eliminates the need for magnetic contactors (MCs). Refer to page 8 for details.

Improved Power Factor

The high power factor allows you to reduce the power supply capacity. Refer to page 5 for details.

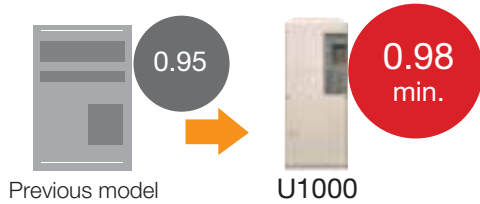

High-speed Operation!

Output frequencies are supported up to 400 Hz.

Solve Noise Problems!

Models are available with built-in EMC noise filters to reduce noise generated by AC drives.

Commercial Power Switching

Switching to and from commercial power is possible without phase detectors, contactors, and other such peripheral devices.

Note: V/f control without a PG must be used.

No contactors required

Save energy

No phase detector required

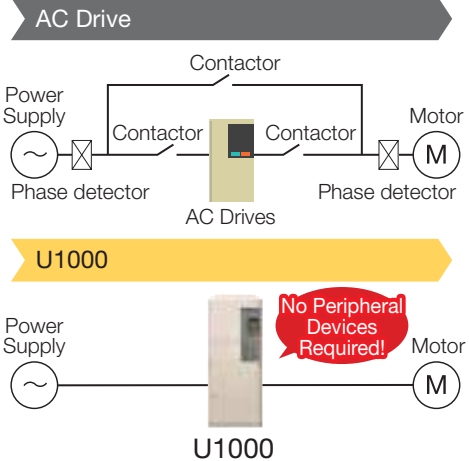
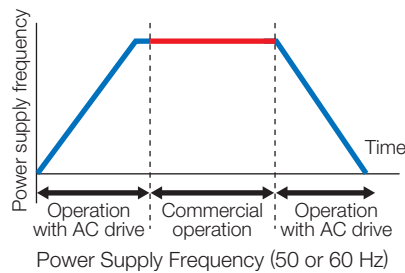

Maintenance Even during Power Interruptions!

A built-in 24-V power supply unit lets you check parameters even when the main circuit power supply is OFF.

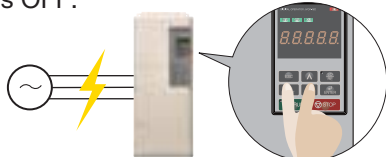

Precise Operation!

A speed response of 250 Hz* enables rapid following of AC drive frequency references.

*: Closed-loop vector control, Closed-loop vector control for PM

Cutting-Edge Torque Characteristics

Powerful torque at 0 Hz, without a motor encoder* Once out of reach for AC drives, Yaskawa now offers advanced control features without a motor encoder. Achieve even more powerful starting torque at zero speed with an IPM motor.

* No speed sensors or pole sensors required.



Synchronous Motor

- Advanced Open Loop Vector Control for PM
200% rated torque at 0 r/min*¹,
speed range of 1: 100*²

Note: Valid when high frequency injection is enabled (n8-57=1).

- Closed Loop Vector Control for PM
200% rated torque at 0 r/min*¹,
speed range of 1: 1500

*1: Achieving this torque output requires a larger capacity models.

*2: Contact your Yaskawa or nearest agent when using PM motors except SSR1 series or SST4 series motors manufactured by Yaskawa Motor Co., Ltd.

■ Torque characteristics
Advanced Open Loop Vector
Control for PM with an IPM motor

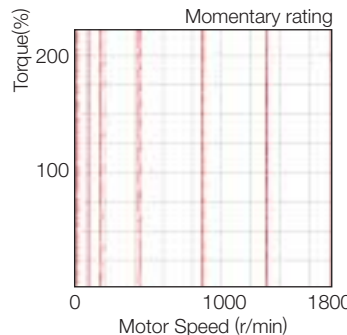

■ Comparing the speed control range
Advanced Open Loop Vector
Control for PM with an IPM motor

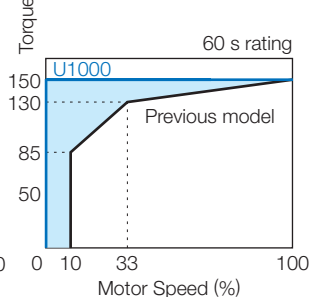

◎ High-performance current vector control achieves powerful starting torque with an induction motor.



Induction Motor

* Achieving this torque output requires a larger capacity models.

- Open Loop Vector Control
200% rated torque at 0.3 Hz*, speed range of 1:200

- Closed Loop Vector Control
200% rated torque at 0 r/min*, speed range of 1:1500

Environmental Features

Protective Design

A variety of protective designs are available to reinforce the drive against moisture, dust, oil mist, vibration, corrosive sulfur gas, conductive particles, and other harsh environments.

RoHS

All standard products are fully compliant with the EU's RoHS directive.



Models with built-in EMC filters are available.
(Specify as an option when ordering.)

Models with built-in 24-V power supply units are available.
(Specify as an option when ordering.)

Safety

Safety Regulations

- ◎ The products comply with ISO/EN13849-1 Cat.3 P1e and IEC/EN61508 SIL3 (two safety inputs and one EDM output).
- ◎ An External Device Monitor (EDM) function has also been added to monitor the safety status of the drive.
- ◎ Safety function eliminates the need for the two magnetic contactors that were previously required.

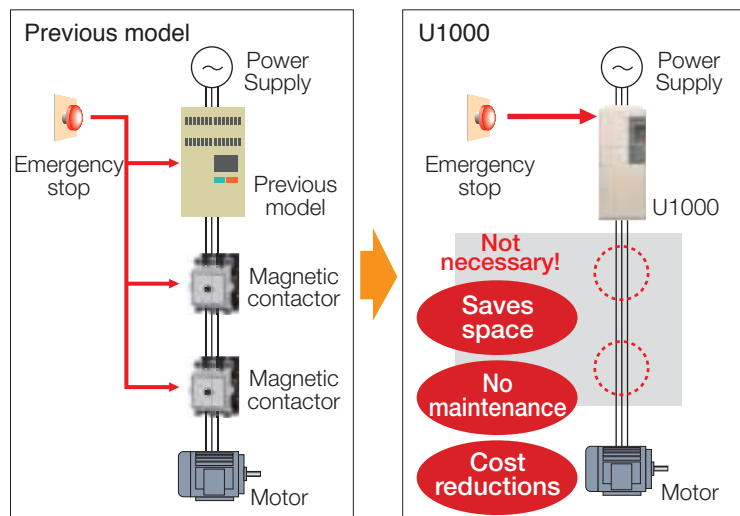

Special models are available for specific applications, such as cranes or elevators.

Customize Your Drive

○ DriveWorksEZ visual programming tool with all models

Simply drag and drop icons to completely customize your drive.

Create special sequences and detection functions, then load them onto the drive.

■ Program a customized sequence

Example : Positioning control without a motor encoder

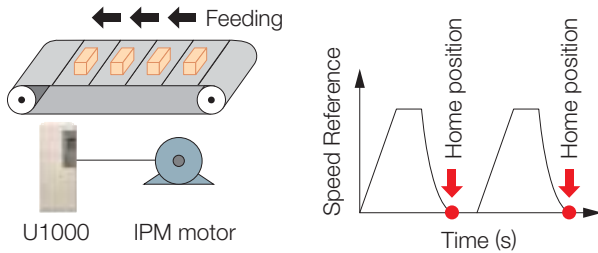

■ USB for connecting to a PC

Example: Machine weakening analysis using torque pulse detection

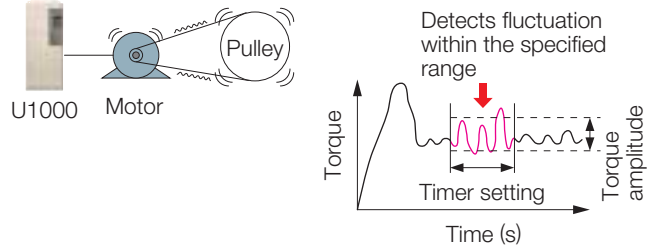

○ USB for connecting to a PC

Note: Drives are also equipped with an RJ-45 comm. port that takes the existing WV103 cable used in Yaskawa's previous models. Simply remove the operator keypad for to the RJ-45 connector.

■ USB port lets the drive connect to a PC



Easy Maintenance

Removable Terminal Board with a Parameter Backup Function

- The terminal block's ability to save parameter setting data makes it a breeze to get the application back online in the event of a failure requiring drive replacement.



Name	Number	Setting
ND/HD Selection	C6-01	1
Control Mode Selection 1	A1-02	0
Frequency Reference Selection 1	b1-01	1
Run Command Selection 1	b1-02	1

No Main Circuit Capacitor Means No Maintenance

Parameter Copy Function

- All standard models are equipped with a Parameter Copy function using the keypad that allows parameter settings to be easily copied from the drive or uploaded for quick setup.
- A USB Copy Unit is also available as an even faster, more convenient way to back up settings and instantly program the drive.

Engineering Tool DriveWizard Plus

- Manage the unique settings for all your drives right on your PC.
- An indispensable tool for drive setup and maintenance. Edit parameters, access all monitors, create customized operation sequences, and observe drive performance with the oscilloscope function.

Comparison with Conventional Inverters











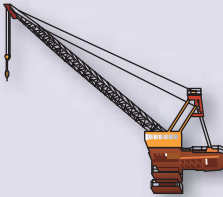



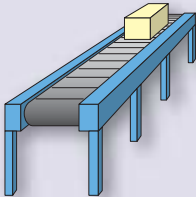



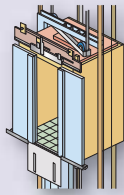



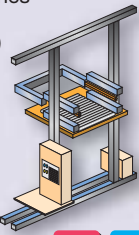









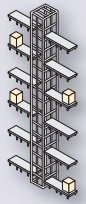

		Low Harmonics	Power Factor	Greater Efficiency	Power Regeneration	Low-Speed Continuous Operation	Compact
U1000	Matrix Converter	◎	◎	◎	◎	◎	◎
Sine-Wave Converter + General-Purpose Inverter	PWM Converter, AC Filter, PWM Inverter	◎	◎	○	◎	△	△
General-Purpose Inverter	Reactor Braking Unit, Braking Unit, Braking resistor, PWM Inverter	△	△	○	×	△	△

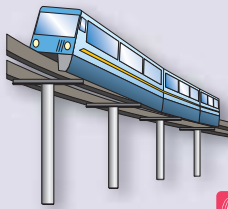



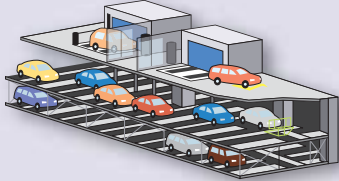





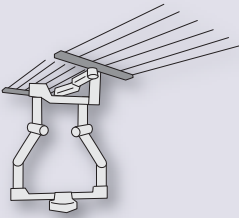



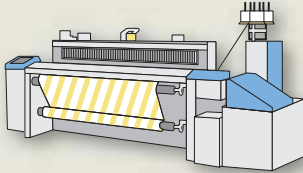



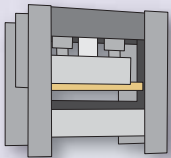



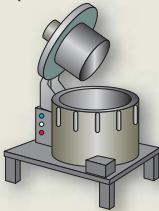

× △ ○ ◎ → Increasing superiority

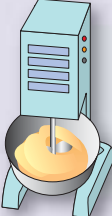
Application Examples

- 
 Improved Power Factor
- 
 Low Harmonics
- 
 Power Regeneration
- 
 Compact

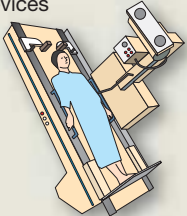
Conveyance Equipment

<p>Cranes, Hoists, and Chain Blocks</p>  <div style="display: flex; justify-content: center; gap: 5px;">     </div>	<p>Conveyors</p>  <div style="display: flex; justify-content: center; gap: 5px;">     </div>	<p>Elevators</p>  <div style="display: flex; justify-content: center; gap: 5px;">     </div>
<p>Stacking Cranes (Automated Warehouses)</p>  <div style="display: flex; justify-content: center; gap: 5px;">     </div>	<p>Escalators</p>  <div style="display: flex; justify-content: center; gap: 5px;">     </div>	<p>Automated Vertical Storage System</p>  <div style="display: flex; justify-content: center; gap: 5px;">     </div>
<p>Slope Transportation Systems (Monorails and Cable Cars)</p>  <div style="display: flex; justify-content: center; gap: 5px;">     </div>	<p>Automatic Parking System</p>  <div style="display: flex; justify-content: center; gap: 5px;">     </div>	

<p>Robots</p> <p>Robots</p>  <div style="display: flex; justify-content: center; gap: 5px;">     </div>	<p>Textiles</p> <p>Weaving Machines</p>  <div style="display: flex; justify-content: center; gap: 5px;">     </div>	<p>Metal Fabrication</p> <p>Presses</p>  <div style="display: flex; justify-content: center; gap: 5px;">     </div>
<p>Chemical Plants</p> <p>Centrifugal Separators, Decanters</p>  <div style="display: flex; justify-content: center; gap: 5px;">     </div>	<p>Food Processing</p> <p>Mixers</p>  <div style="display: flex; justify-content: center; gap: 5px;">     </div>	<p>Medical Facilities</p> <p>Medical Devices</p>  <div style="display: flex; justify-content: center; gap: 5px;">     </div>

Improved Power Factor

Low Harmonics



Power Regeneration

Compact

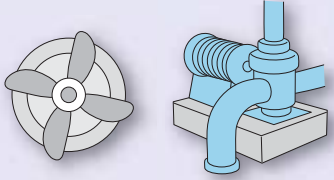

HVAC&R

Paper Manufacturing and Printers

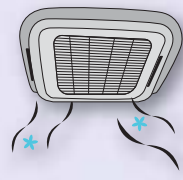

Fans and Pumps

Air Conditioning Systems



Winders and Rewinders

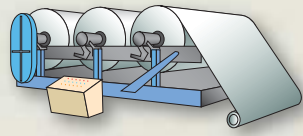

Cooling Towers

Compressors



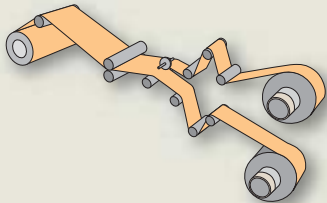

Slitters



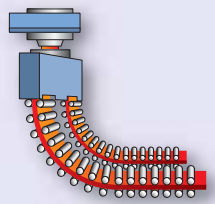

Other

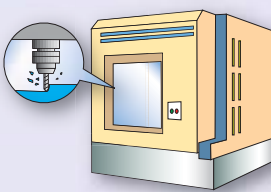

Ladle Turrets

Machine Tools

Load Testing Machine

Features
Product Lineup
Model Selection
Parameter List
Basic Instructions
Standard Specifications
Standard Connection Diagram
Dimensions
Fully-Enclosed Design
Peripheral Devices and Options
Application Notes
Global Service Network

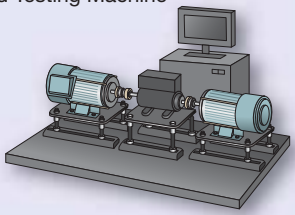

Product Lineup

Three-Phase 200 V

Normal Duty		Heavy Duty	
Model	Rated Output	Model	Rated Output
CIMR-UA2□0028	28	CIMR-UA2□0028	22
CIMR-UA2□0042	42	CIMR-UA2□0042	28
CIMR-UA2□0054	54	CIMR-UA2□0054	42
CIMR-UA2□0068	68	CIMR-UA2□0068	54
CIMR-UA2□0081	81	CIMR-UA2□0081	68
CIMR-UA2□0104	104	CIMR-UA2□0104	81
CIMR-UA2□0130	130	CIMR-UA2□0130	104
CIMR-UA2□0154	154	CIMR-UA2□0154	130
CIMR-UA2□0192	192	CIMR-UA2□0192	154
CIMR-UA2□0248	248	CIMR-UA2□0248	192

Three-Phase 400 V

Normal Duty		Heavy Duty	
Model	Rated Output	Model	Rated Output
CIMR-UA4□0011	11	CIMR-UA4□0011	9.6
CIMR-UA4□0014	14	CIMR-UA4□0014	11
CIMR-UA4□0021	21	CIMR-UA4□0021	14
CIMR-UA4□0027	27	CIMR-UA4□0027	21
CIMR-UA4□0034	34	CIMR-UA4□0034	27
CIMR-UA4□0040	40	CIMR-UA4□0040	34
CIMR-UA4□0052	52	CIMR-UA4□0052	40
CIMR-UA4□0065	65	CIMR-UA4□0065	52
CIMR-UA4□0077	77	CIMR-UA4□0077	65
CIMR-UA4□0096	96	CIMR-UA4□0096	77
CIMR-UA4□0124	124	CIMR-UA4□0124	96
CIMR-UA4□0156	156	CIMR-UA4□0156	124
CIMR-UA4□0180	180	CIMR-UA4□0180	156
CIMR-UA4□0216	216	CIMR-UA4□0216	180
CIMR-UA4□0240	240	CIMR-UA4□0240	216
CIMR-UA4□0302	302	CIMR-UA4□0302	240
CIMR-UA4□0361	361	CIMR-UA4□0361	302
CIMR-UA4□0414	414	CIMR-UA4□0414	361
CIMR-UA4□0477	477	CIMR-UA4□0477	414
CIMR-UA4□0590	590	CIMR-UA4□0590	477
CIMR-UA4□0720	720	CIMR-UA4□0720	590
CIMR-UA4□0900	900	CIMR-UA4□0900	720
CIMR-UA4□0930	930	CIMR-UA4□0930	900

Note: The CIMR-U□4A0477 to CIMR-U□4A0930 are in preparation.

Model Number Key

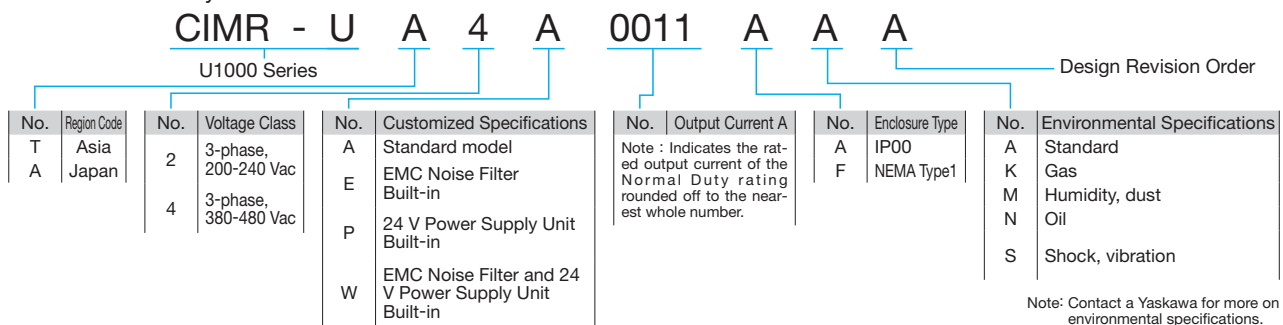



Model Selection

Optimizing Control for Each Application

U1000 offers two separate performance ratings: Normal Duty and Heavy Duty.

Difference between load ratings:

	Normal Duty Rating	Heavy Duty Rating
Parameter settings	C6-01=1	C6-01=0 (default)
Overload tolerance	120% for 60 s	150% for 60 s

Normal Duty Applications

● Applications



● Selecting a Drive

For a fan application motor, set the drive for Normal Duty (C6-01 = 1).

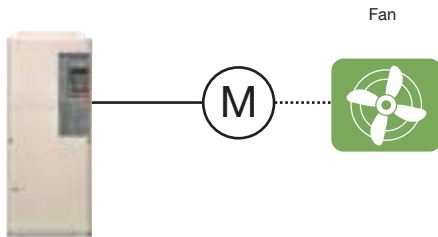

Pump

● Applications



● Selecting a Drive

For a conveyor application motor, set the drive for Heavy Duty (default).

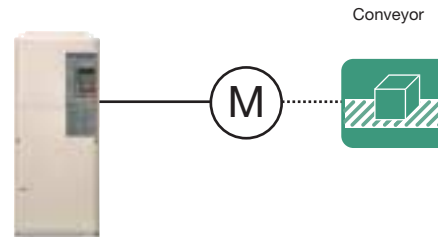

Note: Make sure that the motor rated current is less than rated output current for the drive.

Features

Product Lineup

Model Selection

Parameter List

Basic Instructions

Standard Specifications

Standard Connection Diagram

Dimensions

Fully-Enclosed Design

Peripheral Devices and Options

Application Notes

Global Service Network



Parameter List

Refer to the U1000 Technical Manual for details.

Function	No.	Name	Range	Default	Changes during Run
Initialization	A1-00	Language Selection	0 to 12	1	○
	A1-01	Access Level Selection	0 to 2	2	○
	A1-02	Control Method Selection	0,1,2,3,5,6,7	2	×
	A1-03	Initialize Parameters	0 to 5550	0	×
	A1-04	Password	0 to 9999	0000	×
	A1-05	Password Setting	0 to 9999	0000	×
	A1-06	Application Preset	0 to 7	0	×
User Parameters	A2-01 to A2-32	User Parameters 1 to 32	A1-00 to 04-13	*1	×
	A2-33	User Parameter Automatic Selection	0,1	dep. On A1-06	×
Operation Mode Selection	b1-01	Frequency Reference Selection 1	0 to 4	1	×
	b1-02	Run Command Selection 1	0 to 3	1	×
	b1-03	Stopping Method Selection	0 to 3*2	0	×
	b1-04	Reverse Operation Selection	0,1	0	×
	b1-05	Action Selection below Minimum Output Frequency	0 to 3	0	×
	b1-06	Digital Input Reading	0,1	1	×
	b1-07	LOCAL/REMOTE Run Selection	0,1	0	×
	b1-08	Run Command Selection while in Programming Mode	0 to 2	0	×
	b1-14	Phase Order Selection	0,1	0	×
	b1-15	Frequency Reference Selection 2	0 to 4	0	×
	b1-16	Run Command Selection 2	0 to 3	0	×
	b1-17	Run Command at Power Up	0,1	0	×
	b1-21	Start Condition Selection at Closed Loop Vector Control	0,1	0	×
	b1-24	Commercial Power Operation Switching Selection	0,1	0	×
	b1-25	Commercial Power Supply Operation Cancellation Level	0.4 to 6.0	1.0 Hz	×
	b1-26	Commercial Power Supply Operation Switching Level	0.0 to 3.0	0.2 Hz	×
DC Injection Braking	b2-01	DC Injection Braking Start Frequency	0.0 to 10.0	*2	×
	b2-02	DC Injection Braking Current	0 to 100	50%	×
	b2-03	DC Injection Braking Time at Start	0.00 to 10.00	0.00 s	×
	b2-04	DC Injection Braking Time at Stop	0.00 to 10.00	*2	×
Speed Search	b2-08	Magnetic Flux Compensation Value	0 to 1000	0%	×
	b3-01	Speed Search Selection at Start	0,1	*2	×
	b3-03	Speed Search Deceleration Time	0.1 to 10.0	2.0 s	×
	b3-04	V/f Gain during Speed Search (Speed Estimation type)	10 to 100	*1	×
	b3-05	Speed Search Delay Time	0.0 to 100.0	0.2 s	×
	b3-06	Output Current 1 during Speed Search (Speed Estimation Type)	0.0 to 2.0	*3	×
	b3-08	Current Control Gain during Speed Search (Speed Estimation Type)	0.00 to 6.00	*1	×
	b3-10	Speed Search Detection Compensation Gain (Speed Estimation Type)	1.00 to 1.20	1.05	×
	b3-14	Bi-Directional Speed Search Selection (Speed Estimation Type)	0,1	*2	×
	b3-17	Speed Search Restart Current Level (Speed Estimation Type)	0 to 200	150%	×
	b3-18	Speed Search Restart Detection Time (Speed Estimation Type)	0.00 to 1.00	0.10 s	×
	b3-19	Number of Speed Search Restarts (Speed Estimation Type)	0 to 10	3	×
	b3-24	Speed Search Method Selection	1,2	2	×
	b3-25	Speed Search Wait Time (Speed Estimation Type)	0.0 to 30.0	0.5 s	×
	b3-27	Start Speed Search Select	0,1	0	×
	b3-29	Speed Search Induced Voltage Level	0 to 10	10%	×
	b3-31	Speed Search Operation Current Level 1 (Current Detection 2)	1.50 to 3.50	1.50	×
	b3-32	Speed Search Operation Current Level 2 (Current Detection 2)	0.00 to 1.49	1.20	×
	b3-33	Speed Search Selection when Run Command is Input in Uv	0,1	0	×
b3-50	Backspin Search Direction Judgment Time 1	0.0 to 10.0	0.0 s	×	
b3-51	Backspin Search Direction Judgment Time 2	0.0 to 10.0	0.0 s	×	
b3-52	Backspin Search Deceleration Time 1	0.1 to 10.0	2.0 s	×	
b3-53	Backspin Search Deceleration Time 2	0.1 to 10.0	2.0 s	×	
Timer Function	b4-01	Timer Function On-Delay Time	0.0 to 3000.0	0.0 s	×
	b4-02	Timer Function Off-Delay Time	0.0 to 3000.0	0.0 s	×
	b4-03	H2-01 ON Delay Time	0 to 65536 ms	0 ms	×
	b4-04	H2-01 OFF Delay Time	0 to 65536 ms	0 ms	×
	b4-05	H2-02 ON Delay Time	0 to 65536 ms	0 ms	×
	b4-06	H2-02 OFF Delay Time	0 to 65536 ms	0 ms	×
	b4-07	H2-03 ON Delay Time	0 to 65536 ms	0 ms	×
	b4-08	H2-03 OFF Delay Time	0 to 65536 ms	0 ms	×

Note: Footnotes are listed on page 19.

Function	No.	Name	Range	Default	Changes during Run	
PID Control	b5-01	PID Function Setting	0 to 8	0	×	
	b5-02	Proportional Gain Setting (P)	0.00 to 25.00	1.00	○	
	b5-03	Integral Time Setting (I)	0.0 to 360.0	1.0 s	○	
	b5-04	Integral Limit Setting	0.0 to 100.0	100.0%	○	
	b5-05	Derivative Time (D)	0.00 to 10.00	0.00 s	○	
	b5-06	PID Output Limit	0.0 to 100.0	100.0%	○	
	b5-07	PID Offset Adjustment	-100.0 to +100.0	0.0%	○	
	b5-08	PID Primary Delay Time Constant	0.00 to 10.00	0.00 s	○	
	b5-09	PID Output Level Selection	0,1	0	×	
	b5-10	PID Output Gain Setting	0.00 to 25.00	1.00	○	
	b5-11	PID Output Reverse Selection	0,1	0	×	
	b5-12	PID Feedback Loss Detection Selection	0 to 5	0	×	
	b5-13	PID Feedback Low Detection Level	0 to 100	0%	×	
	b5-14	PID Feedback Low Detection Time	0.0 to 25.5	1.0 s	×	
	b5-15	PID Sleep Function Start Level	0.0 to 400.0*2	*2	×	
	b5-16	PID Sleep Delay Time	0.0 to 25.5	0.0 s	×	
	b5-17	PID Accel/Decel Time	0.0 to 6000.0	0.0 s	×	
	b5-18	PID Setpoint Selection	0,1	0	×	
	b5-19	PID Setpoint Value	0.00 to 100.00	0.00%	○	
	b5-20	PID Setpoint Scaling	0 to 3	1	×	
	b5-34	PID Output Lower Limit	-100.0 to +100.0	0.0%	○	
	b5-35	PID Input Limit	0.0 to 1000.0	1000.0%	○	
	b5-36	PID Feedback High Detection Level	0 to 100	100%	×	
	b5-37	PID Feedback High Detection Time	0.0 to 25.5	1.0 s	×	
	b5-38	PID Setpoint User Display	1 to 60000	dep. On b5-20	×	
	b5-39	PID Setpoint Display Digits	0 to 3	0	×	
	b5-40	Frequency Reference Monitor Content during PID	0,1	0	×	
	b5-47	PID Output Reverse Selection 2	0,1	1	×	
	Dwell Function	b6-01	Dwell Reference at Start	0.0 to 400.0*2	*2	×
		b6-02	Dwell Time at Start	0.0 to 10.0	0.0 s	×
		b6-03	Dwell Reference at Stop	0.0 to 400.0*2	*2	×
		b6-04	Dwell Time at Stop	0.0 to 10.0	0.0s	×
	Droop Control	b7-01	Droop Control Gain	0.0 to 100.0	0.0%	○
		b7-02	Droop Control Delay Time	0.03 to 2.00	0.05 s	○
		b7-03	Droop Control Limit Selection	0,1	1	×
	Energy Saving	b8-01	Energy Saving Control Selection	0,1	*2	×
		b8-02	Energy Saving Gain	0.0 to 10.0	*2	○
		b8-03	Energy Saving Control Filter Time Constant	0.00 to 10.00	*1	○
		b8-04	Energy Saving Coefficient Value	0.00 to 655.00	*1	×
b8-05		Power Detection Filter Time	0 to 2000	20 ms	×	
b8-06		Search Operation Voltage Limit	0 to 100	0%	×	
b8-16		Energy Saving Parameter (Ki) for PM Motors	0.00 to 3.00	1.00	×	
b8-17	Energy Saving Parameter (Kt) for PM Motors	0.00 to 3.00	1.00	×		
Zero Servo	b9-01	Zero Servo Gain	0 to 100	5	×	
	b9-02	Zero Servo Completion Width	0 to 16383	10	×	
Acceleration and Deceleration Times	C1-01	Acceleration Time 1	0.0 to 6000.0*1	10.0 s	○	
	C1-02	Deceleration Time 1	0.0 to 6000.0*1	10.0 s	○	
	C1-03	Acceleration Time 2	0.0 to 6000.0*1	10.0 s	○	
	C1-04	Deceleration Time 2	0.0 to 6000.0*1	10.0 s	○	
	C1-05	Acceleration Time 3 (Motor 2 Accel Time 1)	0.0 to 6000.0*1	10.0 s	○	
	C1-06	Deceleration Time 3 (Motor 2 Decel Time 1)	0.0 to 6000.0*1	10.0 s	○	
	C1-07	Acceleration Time 4 (Motor 2 Accel Time 2)	0.0 to 6000.0*1	10.0 s	○	
	C1-08	Deceleration Time 4 (Motor 2 Decel Time 2)	0.0 to 6000.0*1	10.0 s	○	
	C1-09	Fast Stop Time	0.0 to 6000.0*1	10.0 s	○	
	C1-10	Accel/Decel Time Setting Units	0,1	1	×	
	C1-11	Accel/Decel Time Switching Frequency	0.0 to 400.0	*2	×	
S-Curve Characteristics	C2-01	S-Curve Characteristic at Accel Start	0.00 to 10.00	*2	×	
	C2-02	S-Curve Characteristic at Accel End	0.00 to 10.00	0.20 s	×	
	C2-03	S-Curve Characteristic at Decel Start	0.00 to 10.00	0.20 s	×	
	C2-04	S-Curve Characteristic at Decel End	0.00 to 10.00	0.00 s	×	
Slip Compensation	C3-01	Slip Compensation Gain	0.0 to 2.5	*2	○	
	C3-02	Slip Compensation Primary Delay Time	0 to 10000	*2	○	
	C3-03	Slip Compensation Limit	0 to 250	200%	×	



Function	No.	Name	Range	Default	Changes during Run
Slip Compensation	C3-04	Slip Compensation Selection during Regeneration	0 to 2	0	×
	C3-05	Output Voltage Limit Operation Selection	0,1	0	×
	C3-21	Motor 2 Slip Compensation Gain	0.0 to 2.5	dep. On E3-01	○
	C3-22	Motor 2 Slip Compensation Primary Delay Time	0 to 10000	dep. On E3-01	○
	C3-23	Motor 2 Slip Compensation Limit	0 to 250	dep. On E3-01	×
	C3-24	Motor 2 Slip Compensation Selection during Regeneration	0 to 2	dep. On E3-01	×
Torque Compensation	C4-01	Torque Compensation Gain	0.00 to 2.50	*2	○
	C4-02	Torque Compensation Primary Delay Time	0 to 60000	*1	○
	C4-03	Torque Compensation at Forward Start	0.0 to 200.0	0.0%	×
	C4-04	Torque Compensation at Reverse Start	-200.0 to 0.0	0.0%	×
	C4-05	Torque Compensation Time Constant	0 to 200	10 ms	×
	C4-07	Motor 2 Torque Compensation Gain	0.00 to 2.50	1.00	○
Automatic Speed Regulator (ASR)	C5-01	ASR Proportional Gain 1	0.00 to 300.00	*2	○
	C5-02	ASR Integral Time 1	0.000 to 10.000	*2	○
	C5-03	ASR Proportional Gain 2	0.00 to 300.00	*2	○
	C5-04	ASR Integral Time 2	0.000 to 10.000	*2	○
	C5-05	ASR Limit	0.0 to 20.0	5.0%	×
	C5-06	ASR Primary Delay Time Constant	0.000 to 0.500	*2	×
	C5-07	ASR Gain Switching Freque	0.0 to 400.0*2	*2	×
	C5-08	ASR Integral Limit	0 to 400	400%	×
	C5-12	Integral Operation during Accel/Decel	0,1	0	×
	C5-17	Motor Inertia	0.0001 to 600.00	*1	×
	C5-18	Load Inertia Ratio	0.0 to 6000.0	1.0	×
	C5-21	Motor 2 ASR Proportional Gain 1	0.00 to 300.00	dep. On E3-01	○
	C5-22	Motor 2 ASR Integral Time 1	0.000 to 10.000	dep. On E3-01	○
	C5-23	Motor 2 ASR Proportional Gain 2	0.00 to 300.00	dep. On E3-01	○
	C5-24	Motor 2 ASR Integral Time 2	0.000 to 10.000	dep. On E3-01	○
	C5-25	Motor 2 ASR Limit	0.0 to 20.0	5.0%	×
	C5-26	Motor 2 ASR Primary Delay Time Constant	0.000 to 0.500	dep. On E3-01	×
	C5-27	Motor 2 ASR Gain Switching Frequency	0.0 to 400.0	0.0Hz	×
	C5-28	Motor 2 ASR Integral Limit	0 to 400	400%	×
	C5-29	Speed Response Selection	0,1	0	×
C5-32	Integral Operation during Accel/Decel for Motor 2	0,1	0	×	
C5-37	Motor 2 Inertia	0.0001 to 600.00	*1	×	
C5-38	Motor 2 Load Inertia Ratio	0.0 to 6000.0	1.0	×	
Carrier Frequency	C6-01	Drive Duty Mode Selection	0,1	0	×
	C6-02	Carrier Frequency Selection	1 to 4,F	*1	×
	C6-03	Carrier Frequency Upper Limit	4.0 to 10.0*1	*1	×
	C6-04	Carrier Frequency Lower Limit	4.0 to 10.0*1	*1	×
	C6-05	Carrier Frequency Proportional Gain	0 to 99	*1	×
	C6-09	Carrier Frequency during Rotational Auto-Tuning	0,1	0	×
Voltage Adjustment	C7-43	Input Voltage Offset Adjustment	0000,0002	0000	×
	C7-56	Power Factor Control Selection	0,1	0	×
	C7-60	Output Voltage Limit Mode Selection	0,1	1	×

Note: Footnotes are listed on page 19.

Function	No.	Name	Range	Default	Changes during Run
Frequency Reference	d1-01	Frequency Reference 1	0.00 to 400.00	0.00 Hz	○
	d1-02	Frequency Reference 2			○
	d1-03	Frequency Reference 3			○
	d1-04	Frequency Reference 4			○
	d1-05	Frequency Reference 5			○
	d1-06	Frequency Reference 6			○
	d1-07	Frequency Reference 7			○
	d1-08	Frequency Reference 8			○
	d1-09	Frequency Reference 9			○
	d1-10	Frequency Reference 10			○
	d1-11	Frequency Reference 11			○
	d1-12	Frequency Reference 12			○
	d1-13	Frequency Reference 13			○
	d1-14	Frequency Reference 14			○
	d1-15	Frequency Reference 15			○
	d1-16	Frequency Reference 16			○
	d1-17	Jog Frequency Reference			6.00 Hz
Frequency Upper/Lower Limits	d2-01	Frequency Reference Upper Limit	0.0 to 110.0	100.0%	×
	d2-02	Frequency Reference Lower Limit	0.0 to 110.0	0.0%	×
	d2-03	Master Speed Reference Lower Limit	0.0 to 110.0	0.0%	×
Jump Frequency	d3-01	Jump Frequency 1	0.0 to 400.0	0.0 Hz	×
	d3-02	Jump Frequency 2			×
	d3-03	Jump Frequency 3			×
	d3-04	Jump Frequency Width			0.0 to 20.0
Frequency Reference Hold and Up/Down 2 Function	d4-01	Frequency Reference Hold Function Selection	0,1	0	×
	d4-03	Frequency Reference Bias Step (Up/Down 2)	0.00 to 99.99	0.00 Hz	○
	d4-04	Frequency Reference Bias Accel/Decel (Up/Down 2)	0,1	0	○
	d4-05	Frequency Reference Bias Operation Mode Selection (Up/Down 2)	0,1	0	○
	d4-06	Frequency Reference Bias (Up/Down 2)	-99.9 to +100.0	0.0%	×
	d4-07	Analog Frequency Reference Fluctuation Limit (Up/Down 2)	0.1 to 100.0	1.0%	○
	d4-08	Frequency Reference Bias Upper Limit (Up/Down 2)	0.0 to 100.0	100.0%	○
	d4-09	Frequency Reference Bias Lower Limit (Up/Down 2)	-99.9 to 0.0	0.0%	○
	d4-10	Up/Down Frequency Reference-Limit Selection	0,1	0	×
	Torque Control	d5-01	Torque Control Selection	0,1	0
d5-02		Torque Reference Delay Time	0 to 1000	*2	×
d5-03		Speed Limit Selection	1,2	1	×
d5-04		Speed Limit	-120 to +120	0%	×
d5-05		Speed Limit Bias	0 to 120	10%	×
d5-06		Speed/Torque Control Switchover Time	0 to 1000	0 ms	×
d5-08		Unidirectional Speed Limit Bias	0,1	1	×
Field Weakening and Field Forcing		d6-01	Field Weakening Level	0 to 100	80%
	d6-02	Field Weakening Frequency Limit	0.0 to 400.0	0.0 Hz	×
	d6-03	Field Forcing Selection	0,1	0	×
	d6-06	Field Forcing Limit	100 to 400	400%	×
Offset Frequency	d7-01	Offset Frequency 1	-100.0 to +100.0	0.0%	○
	d7-02	Offset Frequency 2			○
	d7-03	Offset Frequency 3			○
V/f Pattern for Motor 1	E1-03	V/f Pattern Selection	0 to F*2	F	×
	E1-04	Maximum Output Frequency	40.0 to 400.0*1	*1	×
	E1-05	Maximum Voltage	0.0 to 255.0*4	*1,*4	×
	E1-06	Base Frequency	0.0 to E1-04*1	*1	×
	E1-07	Middle Output Frequency	0.0 to E1-04	*1	×
	E1-08	Middle Output Frequency Voltage	0.0 to 255.0*4	*1,*4	×
	E1-09	Minimum Output Frequency	0.0 to E1-04*1	*1	×
	E1-10	Minimum Output Frequency Voltage	0.0 to 255.0*4	*1,*4	×

Features
Product Lineup
Model Selection
Parameter List
Basic Instructions
Standard Specifications
Standard Connection Diagram
Dimensions
Fully-Enclosed Design
Peripheral Devices and Options
Application Notes
Global Service Network



Parameter List (continued)

Function	No.	Name	Range	Default	Changes during Run	
V/f Pattern for Motor 1	E1-11	Middle Output Frequency 2	0.0 to E1-04	0.0 Hz	×	
	E1-12	Middle Output Frequency Voltage 2	0.0 to 255.0*4	0.0 V	×	
	E1-13	Base Voltage	0.0 to 255.0*4	0.0 V *4	×	
Motor 1 Parameters	E2-01	Motor Rated Current	10% to 150% of the drive rated current	*1	×	
	E2-02	Motor Rated Slip	0.00 to 20.00	*1	×	
	E2-03	Motor No-Load Current	0 to E2-01	*1	×	
	E2-04	Number of Motor Poles	2 to 48	4	×	
	E2-05	Motor Line-to-Line Resistance	0.000 to 65.000*1	*1	×	
	E2-06	Motor Leakage Inductance	0.0 to 40.0	*1	×	
	E2-07	Motor Iron-Core Saturation Coefficient 1	0.00 to 0.50	0.50	×	
	E2-08	Motor Iron-Core Saturation Coefficient 2	E2-07 to 0.75	0.75	×	
	E2-09	Motor Mechanical Loss	0.0 to 10.0	0.0%	×	
	E2-10	Motor Iron Loss for Torque Compensation	0 to 65535	*1	×	
	E2-11	Motor Rated Power	0.00 to 650.00	*1	×	
V/f Pattern for Motor 2	E3-01	Motor 2 Control Mode Selection	0 to 3	0	×	
	E3-04	Motor 2 Max. Output Frequency	40.0 to 400.0	dep. On E3-01	×	
	E3-05	Motor 2 Max. Voltage	0.0 to 255.0*4	dep. On E3-01*4	×	
	E3-06	Motor 2 Base Frequency	0.0 to E3-04	dep. On E3-01	×	
	E3-07	Motor 2 Mid Output Frequency	0.0 to E3-04	dep. On E3-01	×	
	E3-08	Motor 2 Mid Output Frequency Voltage	0.0 to 255.0*4	dep. On E3-01*4	×	
	E3-09	Motor 2 Minimum Output Frequency	0.0 to E3-04	dep. On E3-01	×	
	E3-10	Motor 2 Minimum Output Frequency Voltage	0.0 to 255.0*4	dep. On E3-01*4	×	
	E3-11	Motor 2 Mid Output Frequency 2	0.0 to E3-04	0.0 Hz	×	
	E3-12	Motor 2 Mid Output Frequency Voltage 2	0.0 to 255.0*4	0.0 V *1, *4	×	
	E3-13	Motor 2 Base Voltage	0.0 to 255.0*4	0.0 V *1, *4	×	
	Motor 2 Parameters	E4-01	Motor 2 Rated Current	10% to 150% of the drive rated current	*1	×
		E4-02	Motor 2 Rated Slip	0.00 to 20.00	*1	×
E4-03		Motor 2 No-Load Current	0 to E4-01	*1	×	
E4-04		Motor 2 Motor Poles	2 to 48	4	×	
E4-05		Motor 2 Line-to-Line Resistance	0.000 to 65.000*1	*1	×	
E4-06		Motor 2 Leakage Inductance	0.0 to 40.0	*1	×	
E4-07		Motor 2 Motor Iron-Core Saturation Coefficient 1	0.00 to 0.50	0.50	×	
E4-08		Motor 2 Motor Iron-Core Saturation Coefficient 2	E4-07 to 0.75	0.75	×	
E4-09		Motor 2 Mechanical Loss	0.0 to 10.0	0.0%	×	
E4-10		Motor 2 Iron Loss	0 to 65535	*1	×	
E4-11		Motor 2 Rated Power	0.00 to 650.00	*1	×	
PM Motor Settings	E5-01	Motor Code Selection (for PM Motors)	0000 to FFFF	*1	×	
	E5-02	Motor Rated Power (for PM Motors)	0.10 to 650.00	dep. On E5-01	×	
	E5-03	Motor Rated Current (for PM Motors)	10% to 150% of the drive rated current	dep. On E5-01	×	
	E5-04	Number of Motor Poles (for PM Motors)	2 to 48	dep. On E5-01	×	
	E5-05	Motor Stator Resistance (r1) (for PM Motors)	0.000 to 65.000	dep. On E5-01	×	
	E5-06	Motor d-Axis Inductance (Ld) (for PM Motors)	0.00 to 300.00	dep. On E5-01	×	
	E5-07	Motor q-Axis Inductance (Lq) (for PM Motors)	0.00 to 600.00	dep. On E5-01	×	
	E5-09	Motor Induction Voltage Constant 1 (Ke) (for PM Motors)	0.0 to 2000.0	dep. On E5-01	×	

Note: Footnotes are listed on page 19.

Function	No.	Name	Range	Default	Changes during Run	
PM Motor Settings	E5-11	Encoder Z-pulse Offset ($\Delta \theta$) (for PM Motors)	-180 to +180	0.0 deg	×	
	E5-24	Motor Induction Voltage Constant 2 (Ke) (for PM Motors)	0.0 to 6500.0	dep. On E5-01	×	
	E5-25	Polarity Switch for Initial Polarity Estimation (for PM Motors)	0,1	0	×	
PG Speed Control Card Settings (PG-B3/PG-F3/PG-RT3/PG-X3)	F1-01	PG 1 Pulses Per Revolution	0 to 60000	*2	×	
	F1-02	Operation Selection at PG Open Circuit (PGo)	0 to 4	1	×	
	F1-03	Operation Selection at Overspeed (oS)	0 to 3	1	×	
	F1-04	Operation Selection at Speed Deviation (dEv)	0 to 3	3	×	
	F1-05	PG 1 Rotation Selection	0,1	*2	×	
	F1-06	PG 1 Division Rate for PG Pulse Monitor	001 to 032, 102 to 132	1	×	
	F1-08	Overspeed Detection Level	0 to 120	115%	×	
	F1-09	Overspeed Detection Delay Time	0.0 to 2.0	*2	×	
	F1-10	Excessive Speed Deviation Detection Level	0 to 50	10%	×	
	F1-11	Excessive Speed Deviation Detection Delay Time	0.0 to 10.0	0.5 s	×	
	F1-12	PG 1 Gear Teeth 1	0 to 1000	0	×	
	F1-13	PG 1 Gear Teeth 2	0 to 1000	0	×	
	F1-14	PG Open-Circuit Detection Time	0.0 to 10.0	2.0 s	×	
	F1-18	dv3 Detection Selection	0 to 10	10	×	
	F1-19	dv4 Detection Selection	0 to 5000	128	×	
	F1-20	PG Option Card Disconnect Detection 1	0,1	1	×	
	F1-21	PG 1 Signal Selection	0,1	0	×	
	F1-30	PG Card Option Port for Motor 2 Selection	0,1	1	×	
	F1-31	PG 2 Pulses Per Revolution	0 to 60000	600 ppr	×	
	F1-32	PG 2 Rotation Selection	0,1	0	×	
	F1-33	PG 2 Gear Teeth 1	0 to 1000	0	×	
	F1-34	PG 2 Gear Teeth 2	0 to 1000	0	×	
	F1-35	PG 2 Division Rate for Pulse Monitor	1 to 132	1	×	
	F1-36	PG Option Card Disconnect Detection 2	0,1	1	×	
	F1-37	PG 2 Signal Selection	0,1	0	×	
	F1-50	Encoder Selection	0 to 2	0	×	
	F1-51	PGoH Detection Level	1 to 100	80%	×	
	F1-52	Communication Speed of Serial Encoder Selection	0 to 3	0	×	
	Analog Input Card Settings (AI-A3)	F2-01	Analog Input Option Card Operation Selection	0,1	0	×
		F2-02	Analog Input Option Card Gain	-999.9 to +999.9	100.0%	○
		F2-03	Analog Input Option Card Bias	-999.9 to +999.9	0.0%	○
	Digital Input Card Settings (DI-A3)	F3-01	Digital Input Option Card Input Selection	0 to 7	0	×
F3-03		Digital Input Option DI-A3 Data Length Selection	0 to 2	2	×	
Analog Monitor Card Settings (AO-A3)	F4-01	Terminal V1 Monitor Selection	000 to 999	102	×	
	F4-02	Terminal V1 Monitor Gain	-999.9 to +999.9	100.0%	○	
	F4-03	Terminal V2 Monitor Selection	000 to 999	103	×	
	F4-04	Terminal V2 Monitor Gain	-999.9 to +999.9	50.0%	○	
	F4-05	Terminal V1 Monitor Bias	-999.9 to +999.9	0.0%	○	
	F4-06	Terminal V2 Monitor Bias	-999.9 to +999.9	0.0%	○	
	F4-07	Terminal V1 Signal Level	0,1	0	×	
	F4-08	Terminal V2 Signal Level	0,1	0	×	
Digital Output Card Settings (DO-A3)	F5-01	Terminal P1-PC Output Selection	0 to 1A7	0	×	
	F5-02	Terminal P2-PC Output Selection	0 to 1A7	1	×	
	F5-03	Terminal P3-PC Output Selection	0 to 1A7	2	×	
	F5-04	Terminal P4-PC Output Selection	0 to 1A7	4	×	
	F5-05	Terminal P5-PC Output Selection	0 to 1A7	6	×	
	F5-06	Terminal P6-PC Output Selection	0 to 1A7	37	×	
	F5-07	Terminal M1-M2 Output Selection	0 to 1A7	F	×	
	F5-08	Terminal M3-M4 Output Selection	0 to 1A7	F	×	
	F5-09	DO-A3 Output Mode Selection	0 to 2	0	×	



Function	No.	Name	Range	Default	Changes during Run	
Communication Option Card (SI-C3, SI-EM3, SI-EN3, SI-ET3, SI-N3, SI-P3, SI-T3, and SI-W3)	F6-01	Communications Error Operation Selection	0 to 3	1	×	
	F6-02	External Fault from Comm. Option Detection Selection	0,1	0	×	
	F6-03	External Fault from Comm. Option Operation Selection	0 to 3	1	×	
	F6-06	Torque Reference/Torque Limit Selection from Comm. Option	0,1	0	×	
	F6-07	Multi-Step Speed Enable/Disable Selection when NefRef/ComRef is Selected	0,1	0	×	
	F6-08	Reset Communication Parameters	0,1	0	×	
	F6-04, F6-10, F6-11, F6-14	CC-Link Parameter	—	—	—	
	F6-20 to F6-26	MECHATROLINK-II Parameter	—	—	—	
	F6-20, F6-21, F6-23 to F6-26	MECHATROLINK-III Parameter	—	—	—	
	F6-30 to F6-32	PROFIBUS-DP Parameter	—	—	—	
	F6-35, F6-36	CANopen Parameter	—	—	—	
	F6-50 to F6-63	DeviceNet Parameter	—	—	—	
	F7-01 to F7-16, U6-80 to U6-93, U6-96, U6-99	Modbus TCP/IP Parameter	—	—	—	
	F7-01 to F7-15, F7-17 to F7-42, U6-80 to U6-93, U6-96, U6-99	EtherNet/IP Parameter	—	—	—	
	Communication Option Card (SI-EM3 and SI-EN3)	H1-01	Multi-Function Digital Input Terminal S1 Function Selection	1 to 9F	40(F)**	×
		H1-02	Multi-Function Digital Input Terminal S2 Function Selection	1 to 9F	41(F)**	×
		H1-03	Multi-Function Digital Input Terminal S3 Function Selection	0 to 9F	24	×
		H1-04	Multi-Function Digital Input Terminal S4 Function Selection	0 to 9F	14	×
H1-05		Multi-Function Digital Input Terminal S5 Function Selection	0 to 9F	3(0)**	×	
H1-06		Multi-Function Digital Input Terminal S6 Function Selection	0 to 9F	4(3)**	×	
H1-07		Multi-Function Digital Input Terminal S7 Function Selection	0 to 9F	6(4)**	×	
H1-08		Multi-Function Digital Input Terminal S8 Function Selection	0 to 9F	8	×	
Multi-Function Digital Outputs	H2-01	Terminal M1-M2 Function Selection (Relay)	0 to 192	0	×	
	H2-02	Terminal P1-PC Function Selection (Open-collector)	0 to 192	1	×	
	H2-03	Terminal P2-PC Function Selection (Open-collector)	0 to 192	2	×	
	H2-06	Watt Hour Output Unit Selection	1 to 4	1	×	
	H2-07	Memobus Regs1 Address Select	1 to 1FFFH	1	×	
	H2-08	Memobus Regs1 Bit Select	0 to FFFFH	0	×	
	H2-09	Memobus Regs2 Address Select	1 to 1FFFH	1	×	
	H2-10	Memobus Regs2 Bit Select	0 to FFFFH	0	×	
	Multi-Function Analog Inputs	H3-01	Terminal A1 Signal Level Selection	0,1	0	×
		H3-02	Terminal A1 Function Selection	0 to 32	0	×
H3-03		Terminal A1 Gain Setting	-999.9 to +999.9	100.0%	○	
H3-04		Terminal A1 Bias Setting	-999.9 to +999.9	0.0%	○	
H3-05		Terminal A3 Signal Level Selection	0,1	0	×	
H3-06		Terminal A3 Function Selection	0 to 32	2	×	
H3-07		Terminal A3 Gain Setting	-999.9 to +999.9	100.0%	○	
H3-08		Terminal A3 Bias Setting	-999.9 to +999.9	0.0%	○	
H3-09		Terminal A2 Signal Level Selection	0 to 3	2	×	
H3-10		Terminal A2 Function Selection	0 to 32	0	×	
H3-11		Terminal A2 Gain Setting	-999.9 to +999.9	100.0%	○	
H3-12		Terminal A2 Bias Setting	-999.9 to +999.9	0.0%	○	
H3-13		Analog Input Filter Time Constant	0.00 to 2.00	0.03 s	×	
H3-14		Analog Input Terminal Enable Selection	1 to 7	7	×	
H3-16		Terminal A1 Offset	-500 to +500	0	×	
H3-17		Terminal A2 Offset	-500 to +500	0	×	
H3-18		Terminal A3 Offset	-500 to +500	0	×	

Note: Footnotes are listed on page 19.

Function	No.	Name	Range	Default	Changes during Run	
Multi-Function Analog Outputs	H4-01	Multi-Function Analog Output Terminal FM Monitor Selection	000 to 999	102	×	
	H4-02	Multi-Function Analog Output Terminal FM Gain	-999.9 to +999.9	100.0%	○	
	H4-03	Multi-Function Analog Output Terminal FM Bias	-999.9 to +999.9	0.0%	○	
	H4-04	Multi-Function Analog Output Terminal AM Monitor Selection	000 to 999	103	×	
	H4-05	Multi-Function Analog Output Terminal AM Gain	-999.9 to +999.9	50.0%	○	
	H4-06	Multi-Function Analog Output Terminal AM Bias	-999.9 to +999.9	0.0%	○	
	H4-07	Multi-Function Analog Output Terminal FM Signal Level Selection	0,1	0	×	
	H4-08	Multi-Function Analog Output Terminal AM Signal Level Selection	0,1	0	×	
MEMOBUS/Modbus Serial Communication	H5-01	Drive Slave Address	0 to FFH	1FH	×	
	H5-02	Communication Speed Selection	0 to 8	3	×	
	H5-03	Communication Parity Selection	0 to 2	0	×	
	H5-04	Stopping Method After Communication Error (CE)	0 to 3	3	×	
	H5-05	Communication Fault Detection Selection	0,1	1	×	
	H5-06	Drive Transmit Wait Time	5 to 65	5 ms	×	
	H5-07	RTS Control Selection	0,1	1	×	
	H5-09	Communication Fault Detection Time	0.0 to 10.0	2.0 s	×	
	H5-10	Unit Selection for MEMOBUS/Modbus Register 0025H	0,1	0	×	
	H5-11	Communications ENTER Function Selection	0,1	0	×	
	H5-12	Run Command Method Selection	0,1	0	×	
	H5-17	Operation Selection when Unable to Write into EEPROM	0,1	0	×	
	H5-18	Filter Time Constant for Motor Speed Monitoring	0 to 100	0 ms	×	
	Pulse Train Input/Output	H6-01	Pulse Train Input Terminal RP Function Selection	0 to 3	0	×
		H6-02	Pulse Train Input Scaling	100 to 32000	1440 Hz	○
		H6-03	Pulse Train Input Gain	0.0 to 1000.0	100.0%	○
		H6-04	Pulse Train Input Bias	-100.0 to +100.0	0.0%	○
		H6-05	Pulse Train Input Filter Time	0.00 to 2.00	0.10 s	○
H6-06		Pulse Train Monitor Selection	000,031,101,102,105,116,501,502,801 to 809	102	○	
H6-07		Pulse Train Monitor Scaling	0 to 32000	1440 Hz	○	
H6-08		Pulse Train Input Minimum Frequency	0.1 to 1000.0	0.5 Hz	×	
Motor Protection	L1-01	Motor Overload Protection Selection	0 to 6	*2	×	
	L1-02	Motor Overload Protection Time	0.1 to 5.0	1.0 min	×	
	L1-03	Motor Overheat Alarm Operation Selection (PTC input)	0 to 3	3	×	
	L1-04	Motor Overheat Fault Operation Selection (PTC input)	0 to 2	1	×	
	L1-05	Motor Temperature Input Filter Time (PTC input)	0.00 to 10.00	0.20 s	×	
	L1-08	oL1 Current Lvl	0.0 or 10% to 150% of the drive rated current	0.0 A	×	
	L1-09	oL1 Current Lvl (for 2nd motor)	0.0 or 10% to 150% of the drive rated current	0.0 A	×	
	L1-13	Continuous Electrothermal Operation Selection	0,1	1	×	
	Momentary Power Loss Ride-Thru	L2-01	Momentary Power Loss Operation Selection	0 to 2	0	×
L2-02		Momentary Power Loss Ride-Thru Time	0.0 to 2.5	0.5 s	×	
L2-03		Momentary Power Loss Minimum Baseblock Time	0.1 to 5.0	*1	×	
L2-04		Momentary Power Loss Voltage Recovery Ramp Time	0.0 to 5.0	*1	×	
L2-07		KEB Acceleration Time	0.00 to 6000.0*1	0.00 s	×	
L2-13		Power Supply Frequency Fault Detection Gain	0.1 to 2.0	1.0	×	
L2-21		Low Input Voltage Detection Level	100 to 200	*1	×	
L2-27		Power Supply Frequency Fault Detection Width	3.0 to 20.0	6.0 Hz	×	
Stall Prevention		L3-01	Stall Prevention Selection during Acceleration	0 to 3	1	×
		L3-02	Stall Prevention Level during Acceleration	0 to 150*1	*1	×
	L3-03	Stall Prevention Limit during Acceleration/Deceleration	0 to 100	50%	×	
	L3-04	Stall Prevention Selection during Deceleration	0,1,4,6*2	1	×	

Features
Product Lineup
Model Selection
Parameter List
Basic Instructions
Standard Specifications
Standard Connection Diagram
Dimensions
Fully-Enclosed Design
Peripheral Devices and Options
Application Notes
Global Service Network



Parameter List (continued)

Function	No.	Name	Range	Default	Changes during Run
Stall Prevention	L3-05	Stall Prevention Selection during Run	0 to 2	1	×
	L3-06	Stall Prevention Level during Run	30 to 150*1	*1	×
	L3-14	Stall Prevention Level during Deceleration	100 to 200*1	*1	×
	L3-22	Deceleration Time at Stall Prevention during Acceleration	0.0 to 6000.0	0.0 s	×
	L3-23	Automatic Reduction Selection for Stall Prevention during Run	0,1	0	×
	L3-27	Stall Prevention Detection Time	0 to 5000	50 ms	×
	L3-36	Vibration Suppression Gain during Acceleration (with Current Limit)	0.0 to 100.0	*2	×
	L3-39	Current-limited Integral Time Constant during Acceleration	1.0 to 1000.0	100.0 ms	×
	L3-40	Current-limited Maximum S-curve Selection during Acceleration	0,1	0	×
	L3-41	Vibration Suppression Gain during Deceleration (with Current Limit)	0.0 to 100.0	*2	×
	L3-44	Current-limited Integral Time Constant during Deceleration	1.0 to 1000.0	100.0 ms	×
	L3-45	Current-limited Maximum S-curve Selection during Deceleration	0,1	0	×
	Speed Detection	L4-01	Speed Agreement Detection Level	0.0 to 400.0*2	*2
L4-02		Speed Agreement Detection Width	0.0 to 20.0	*2	×
L4-03		Speed Agreement Detection Level(+/-)	-400.0 to +400.0*2	*2	×
L4-04		Speed Agreement Detection Width(+/-)	0.0 to 20.0	*2	×
L4-05		Frequency Reference Loss Detection Selection	0,1	0	×
L4-06		Frequency Reference at Reference Loss	0.0 to 100.0	80%	×
L4-07		Speed Agree Detection Selection	0,1	0	×
Fault Restart	L5-01	Number of Auto Restart Attempts	0 to 10	0	×
	L5-02	Auto Restart Fault Output Operation Selection	0,1	0	×
	L5-04	Fault Reset Interval Time	0.5 to 600.0	10.0 s	×
	L5-05	Fault Reset Operation Selection	0,1	0	×
	Torque Detection	L6-01	Torque Detection Selection 1	0 to 8	0
L6-02		Torque Detection Level 1	0 to 300	150%	×
L6-03		Torque Detection Time 1	0.0 to 10.0	0.1 s	×
L6-04		Torque Detection Selection 2	0 to 8	0	×
L6-05		Torque Detection Level 2	0 to 300	150%	×
L6-06		Torque Detection Time 2	0.0 to 10.0	0.1 s	×
L6-08		Mechanical Weakening Detection Operation	0 to 8	0	×
L6-09		Mechanical Weakening Detection Speed Level	-110.0 to +110.0	110.0%	×
L6-10		Mechanical Weakening Detection Time	0.0 to 10.0	0.1 s	×
L6-11		Mechanical Weakening Detection Start Time	0 to 65535	0h	×
Torque Limit		L7-01	Forward Torque Limit	0 to 300	200%
	L7-02	Reverse Torque Limit	0 to 300	200%	×
	L7-03	Forward Regenerative Torque Limit	0 to 300	200%	×
	L7-04	Reverse Regenerative Torque Limit	0 to 300	200%	×
	L7-06	Torque Limit Integral Time Constant	5 to 10000	200 ms	×
	L7-07	Torque Limit Control Method Selection during Accel/Decel	0,1	0	×
	L7-16	Torque Limit Process at Start	0,1	1	×
Drive Protection	L8-02	Overheat Alarm Level	50 to 150	*1	×
	L8-03	Overheat Pre-Alarm Operation Selection	0 to 4	3	×
	L8-07	Output Phase Loss Protection Selection	0 to 2	0	×
	L8-09	Output Ground Fault Detection Selection	0,1	1	×
	L8-10	Heatsink Cooling Fan Operation Selection	0,1	0	×
	L8-11	Heatsink Cooling Fan Off Delay Time	0 to 300	60 s	×
	L8-12	Ambient Temperature Setting	-10 to +50	40°C	×
	L8-15	oL2 Characteristics Selection at Low Speeds	0,1	1	×
	L8-18	Software Current Limit Selection	0,1	0	×
	L8-19	Frequency Reduction Rate during Overheat Pre-Alarm	0.1 to 0.9	0.8	×
	L8-27	Overcurrent Detection Gain	0.0 to 400.0	300.0%	×
	L8-29	Current Unbalance Detection (LF2)	0,2	2	×
	L8-32	Cooling Fan Failure Selection	0 to 2	1	×
	L8-35	Installation Method Selection	0 to 3	*3	×
	L8-38	Carrier Frequency Reduction Selection	0 to 2	*1	×
	L8-40	Carrier Frequency Reduction Off-Delay Time	0.00 to 2.00	*2	×
	L8-41	High Current Alarm Selection	0,1	0	×
	L8-93	LSO Detection Time at Low Speed	0.0 to 10.0	1.0 s	×

Function	No.	Name	Range	Default	Changes during Run
Drive Protection	L8-94	LSO Detection Level at Low Speed	0 to 10	3%	×
	L8-95	Average LSO Frequency at Low Speed	1 to 50	10	×
	L9-03	Carrier Frequency Reduction Level Selection	0,1	0	×
Hunting Prevention	n1-01	Hunting Prevention Selection	0,1	1	×
	n1-02	Hunting Prevention Gain Setting	0.00 to 2.50	1.00	×
	n1-03	Hunting Prevention Time Constant	0 to 500	*3	×
	n1-05	Hunting Prevention Gain while in Reverse	0.00 to 2.50	0.00	×
	Speed Feedback Detection Control (AFR) Tuning	n2-01	Speed Feedback Detection Control (AFR) Gain	0.00 to 10.00	1.00
n2-02		Speed Feedback Detection Control (AFR) Time Constant 1	0 to 2000	50 ms	×
n2-03		Overexcitation Deceleration Gain	0 to 2000	750 ms	×
Overexcitation Braking	n3-13	Overexcitation Deceleration Gain	1.00 to 2.00	1.10	×
Feed Forward Control Tuning	n5-01	Feed Forward Control Selection	0,1	0	×
	n5-02	Motor Acceleration Time	0.001 to 10.000	*1	×
	n5-03	Feed Forward Control Gain	0.00 to 100.00	1.00	×
	n6-01	Online Tuning Selection	0 to 2	0	×
	n6-05	Online Tuning Gain	0.1 to 50.0	1.0	×
PM Motor Control Tuning	n8-01	Initial Rotor Position Estimation Current	0 to 100	50%	×
	n8-02	Pole Attraction Current	0 to 150	80%	×
	n8-11	Induction Voltage Estimation Gain 2	0.0 to 1000.0	dep. On n8-72	×
	n8-14	Polarity Compensation Gain 3	0.000 to 10.000	1.000	×
	n8-15	Polarity Compensation Gain 4	0.000 to 10.000	0.500	×
	n8-21	Motor Ke Gain	0.80 to 1.00	0.90	×
	n8-35	Initial Rotor Position Detection Selection	0 to 2	1	×
	n8-36	High Frequency Injection Level	200 to 1000	500 Hz	×
	n8-37	High Frequency Injection Amplitude	0.0 to 50.0	20%	×
	n8-39	Low Pass Filter Cutoff Frequency for High Frequency Injection	0 to 1000	50 Hz	×
	n8-45	Speed Feedback Detection Control Gain (for PM Motors)	0.00 to 10.00	0.80	×
	n8-47	Pull-In Current Compensation Time Constant (for PM Motors)	0.0 to 100.0	5.0 s	×
	n8-48	Pull-In Current (for PM Motors)	20 to 200	30%	×
	n8-49	d-Axis Current for High Efficiency Control (for PM Motors)	-200.0 to 0.0	dep. On E5-01	×
	n8-51	Acceleration/Deceleration Pull-In Current (for PM Motors)	0 to 200	50%	×
	n8-54	Voltage Error Compensation Time Constant	0.00 to 10.00	1.00 s	×
	n8-55	Load Inertia	0 to 3	0	×
	n8-57	High Frequency Injection	0,1	0	×
	n8-62	Output Voltage Limit (for PM Motors)	0.0 to 230.0*4	200.0 V*4	×
	n8-69	Speed Calculation Gain	0.00 to 20.00	1.00	×
n8-72	Speed Estimation Method Selection	0,1	1	×	
n8-84	Polarity Judge Current	0 to 150	100%	×	
Digital Operator Display Selection	o1-01	Drive Mode Unit Monitor Selection	104 to 914	106	○
	o1-02	User Monitor Selection after Power Up	1 to 5	1	○
	o1-03	Digital Operator Display Selection	0 to 3	*2	×
	o1-04	V/f Pattern Display Unit	0,1	*2	×
	o1-05	LCD Contrast Control	0 to 5	3	○
	o1-10	User-Set Display Units Maximum Value	1 to 60000	dep. On o1-03	×
o1-11	User-Set Display Units Decimal Display	0 to 3	dep. On o1-03	×	
Digital Operator Keypad Functions	o2-01	LO/RE (LOCAL/REMOTE) Key Function Selection	0,1	1	×
	o2-02	STOP Key Function Selection	0,1	1	×
	o2-03	User Parameter Default Value	0 to 2	0	×
	o2-04	Drive Model Selection	—	dep. on drive capacity	×
	o2-05	Frequency Reference Setting Method Selection	0,1	0	×
	o2-06	Operation Selection when Digital Operator is Disconnected	0,1	0	×
	o2-07	Motor Direction at Power Up when Using Operator	0,1	0	×
	o2-09	Reserved	—	—	×



Function	No.	Name	Range	Default	Changes during Run
Copy Function	o3-01	Copy Function Selection	0 to 3	0	×
	o3-02	Copy Allowed Selection	0,1	0	×
Maintenance Monitor Settings	o4-01	Cumulative Operation Time Setting	0 to 9999	0	×
	o4-02	Cumulative Operation Time Selection	0,1	0	×
	o4-03	Cooling Fan Operation Time Setting	0 to 9999	0	×
	o4-05	Capacitor Maintenance Setting	0 to 150	0%	×
	o4-07	DC Bus Pre-Charge Relay Maintenance Setting	0 to 150	0%	×
	o4-09	IGBT Maintenance Setting	0 to 150	0%	×
	o4-11	U2, U3 Initialization	0,1	0	×
	o4-12	kWh Monitor Initialization	0,1	0	×
	o4-13	Number of Run Commands Counter Initialization	0,1	0	×
	o4-19	Power Unit Price	0.00 to 650.00	000.00	×
DriveWorksEZ Parameters	q1-01 to q6-07	DriveWorksEZ Parameters	—	—	×
	r1-01 to r1-40	DriveWorksEZ Connection Parameters 1 to 20 (upper/lower)	—	—	×
Induction Motor Auto-Tuning	T1-00	Motor 1/Motor 2 Selection	1,2	1	×
	T1-01	Auto-Tuning Mode Selection	0,2,3,4,5,8,9	*2	×
	T1-02	Motor Rated Power	0.00 to 650.00	*1	×
	T1-03	Motor Rated Voltage	0.0 to 255.0*4	200.0V*4	×
	T1-04	Motor Rated Current	10% to 150% of the drive rated current	*3	×
	T1-05	Motor Base Frequency	0.0 to 400.0	60.0 Hz	×
	T1-06	Number of Motor Poles	2 to 48	4	×
	T1-07	Motor Base Speed	0 to 24000	1750min ⁻¹	×
	T1-08	PG Number of Pulses Per Revolution	0 to 60000	600 ppr	×
	T1-09	Motor No-Load Current (Stationary Auto-Tuning)	0 to T1-04	—	×
	T1-10	Motor Rated Slip (Stationary Auto-Tuning)	0.00 to 20.00	—	×
T1-11	Motor Iron Loss	0 to 65535	14 W*1	×	
PM Motor Auto-Tuning	T2-01	PM Motor Auto-Tuning Mode Selection	0,1,2,3,8,9,11,13,14	0	×
	T2-02	PM Motor Code Selection	0000 to FFFF	*1	×
	T2-03	PM Motor Type	0,1	1	×
	T2-04	PM Motor Rated Power	0.00 to 650.00	*1	×
	T2-05	PM Motor Rated Voltage	0.0 to 255.0*4	200.0V*4	×
	T2-06	PM Motor Rated Current	10% to 150% of the drive rated current	*3	×
	T2-07	PM Motor Base Frequency	0.0 to 400.0	87.5 Hz	×
	T2-08	Number of PM Motor Poles	2 to 48	6	×
	T2-09	PM Motor Base Speed	0 to 24000	1750min ⁻¹	×
	T2-10	PM Motor Stator Resistance	0.000 to 65.000	dep. On T2-02	×
	T2-11	PM Motor d-Axis Inductance	0.00 to 600.00	dep. On T2-02	×
	T2-12	PM Motor q-Axis Inductance	0.00 to 600.00	dep. On T2-02	×
	T2-13	Induced Voltage Constant Unit Selection	0,1	1	×
	T2-14	PM Motor Induced Voltage Constant (Ke)	0.0 to 2000.0	dep. On T2-02	×
	T2-15	Pull-In Current Level for PM Motor Tuning	0 to 120	30%	×
	T2-16	PG Number of Pulses Per Revolution for PM Motor Tuning	0 to 15000	1024 ppr	×
	T2-17	Encoder Z-Pulse Offset ($\Delta \theta$)	-180.0 to +180.0	0.0 deg	×

Function	No.	Name	Range	Default	Changes during Run
ASR and Inertia Tuning	T3-01	Inertia Tuning Frequency Reference	0.1 to 20.0	3.0 Hz	×
	T3-02	Inertia Tuning Reference Amplitude	0.1 to 10.0	0.5 rad	×
	T3-03	Motor Inertia	0.0001 to 600.00	*1	×
	T3-04	ASR Response Frequency	0.1 to 50.0	10.0 Hz	×

- *1 : Value depends on other related parameter settings. Refer to U1000 Technical Manual for details.
- *2 : Default setting depends on the control mode (A1-02). Refer to U1000 Technical Manual for details.
- *3 : Default setting depends on drive capacity (o2-04). Refer to U1000 Technical Manual for details.
- *4 : Value shown here is for 200 V class drives. Double the value when using a 400 V class drive.
- *5 : Parameter is not reset to the default value when the drive is initialized (A1-03).
- *6 : Value in parenthesis is the default setting for a 3-wire sequence (A1-03=3330).

Features
Product Lineup
Model Selection
Parameter List
Basic Instructions
Standard Specifications
Standard Connection Diagram
Dimensions
Fully-Enclosed Design
Peripheral Devices and Options
Application Notes
Global Service Network

Outstanding operability and quick setup

Operator Names and Functions

Function Key (F1, F2)

The functions assigned to F1 and F2 vary depending on the menu that is currently displayed. The name of each function appears in the lower half of the display window.

Up Arrow Key

Scrolls up to display the next item, selects parameter numbers and increments setting values.

ESC Key

- Returns to the previous display.
- Moves the cursor one space to the left.
- Pressing and holding this button will return to the Frequency Reference display.

RESET Key

- Moves the cursor to the right.
- Resets the drive to clear a fault situation.

RUN Light

Lit while the drive is operating the motor. See below for details.

RUN Key

Starts the drive in the LOCAL mode.

ALM LED Light

(See below for details.)

LO/RE Light

Lit while the operator is selected to run the drive (LOCAL mode).

LO/RE Selection Key

Switches drive control between the operator (LOCAL) and the control circuit terminals (REMOTE). The LED is on when the drive is in the LOCAL mode (operation from keypad).

ENTER Key

- Enters parameter values and settings.
- Selects a menu item to move between displays.

Down Arrow Key

Scrolls down to display the previous item, selects parameter numbers and decrements setting values.

STOP Key

Stops drive operation.

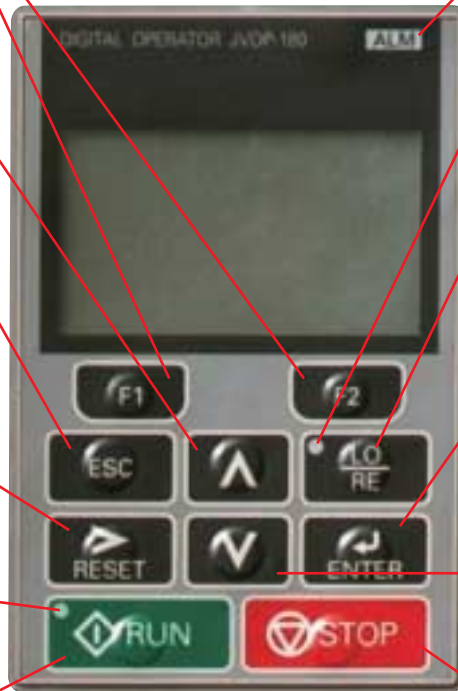

Display Guide

LED	ON	Flashing	Flashing Quickly	OFF
ALM	A fault has occurred.	<ul style="list-style-type: none"> • Alarm situation detected. • Operator error (OPE) • A fault or an error occurred during Auto-Tuning. 	—	Normal operation
LO/RE	Run command assigned to the operator (LOCAL)	—	—	Control assigned to remote location
RUN	During run	<ul style="list-style-type: none"> • During deceleration • Run command is present but the frequency reference is zero. 	<ul style="list-style-type: none"> • During deceleration when a Fast Stop command was entered. • The drive output is shut off by the Safe Disable function. 	Drive is stopped.

How the RUN light works:

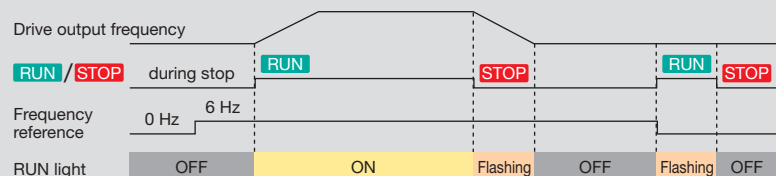



Operation Example

Menu Structure for Digital Operator

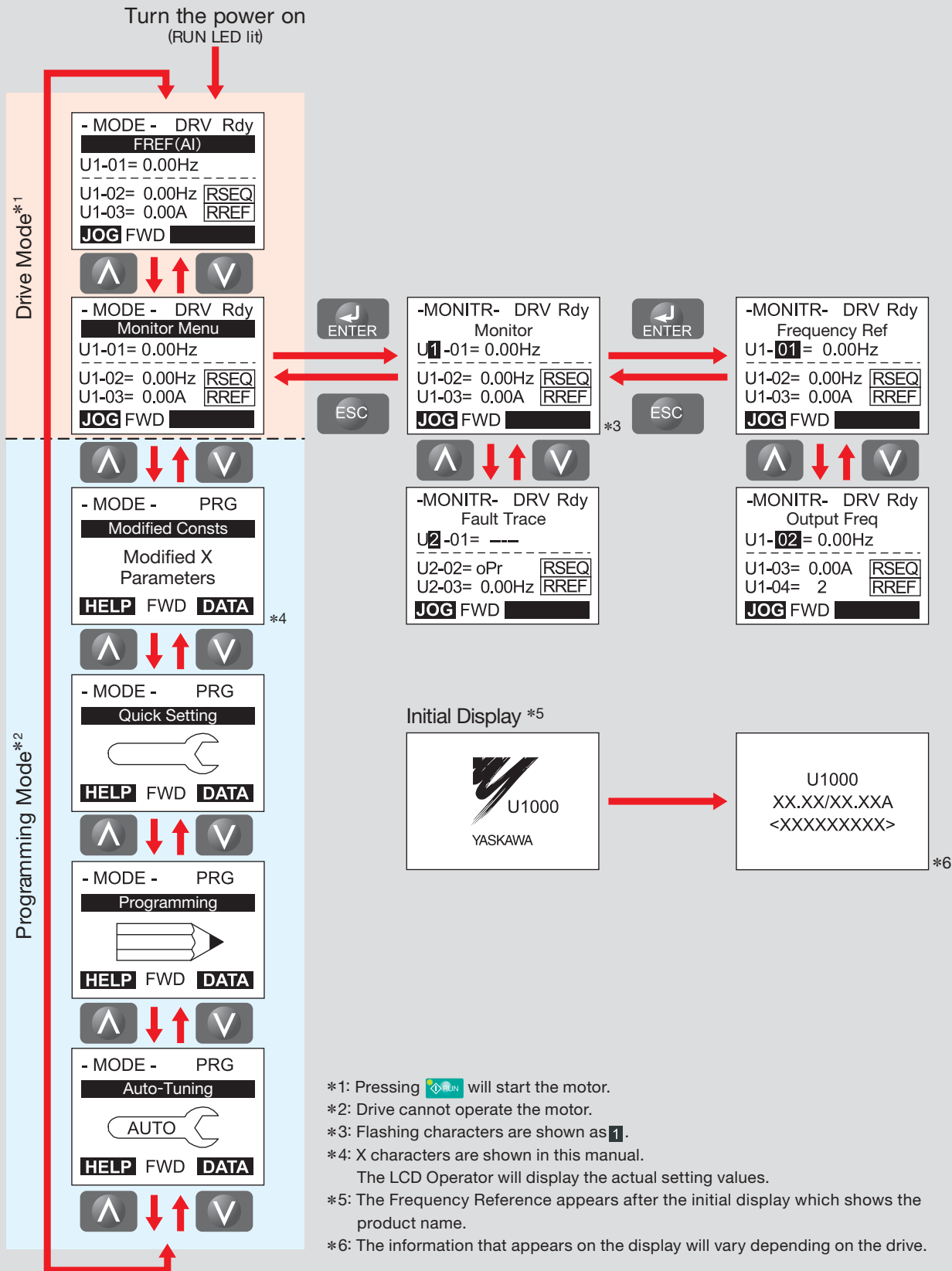

- Features
- Product Lineup
- Model Selection
- Parameter List
- Basic Instructions
- Standard Specifications
- Standard Connection Diagram
- Dimensions
- Fully-Enclosed Design
- Peripheral Devices and Options
- Application Notes
- Global Service Network



Standard Specifications

200 V Class

ND: Normal Duty, HD: Heavy Duty

Model CIMR-U: 2A		0028	0042	0054	0068	0081	0104	0130	0154	0192	0248	
Rated Input/Output	Rated Input	ND	25	38	49	62	74	95	118	140	175	226
	Current* ¹	A	20	25	38	49	62	74	95	118	140	175
	Rated Input	ND	12	17	22	28	34	43	54	64	80	103
	Capacity* ²	kVA	9	12	17	22	28	34	43	54	64	80
	Rated Output	ND	28	42	54	68	81	104	130	154	192	248
	Current* ^{3*4}	A	22	28	42	54	68	81	104	130	154	192
Overload Tolerance		HD Rating: 150% of rated output current for 60 s, ND Rating: 120% of rated output current for 60 s (Derating may be required for repetitive loads)										
Carrier Frequency		4 kHz (User adjustable up to 10 kHz. Derating may be required.)										
Max. Output Voltage		Depends on input voltage										
Max. Output Frequency		400 Hz										
Power	Rated Voltage/Rated Frequency	Three-phase AC power supply: 200 to 240 Vac 50/60 Hz										
	Allowable Voltage Fluctuation	-15% to +10%										
	Allowable Frequency Fluctuation	±3% (Frequency fluctuation rate: 1 Hz/100 ms or less)										
	Allowable Power Voltage Imbalance between Phases	less than 2%										
	Harmonic Current Distortion Rate* ⁵	5% or less (IEEE 519)										
Input Power Factor		0.98 or more (for rated load)										

*1 : Assumes operation at the rated output current. This value may fluctuate based on the power supply side impedance, as well as the input current, power supply transformer, and wiring conditions.

*2 : The rated input capacity is calculated by multiplying the power line voltage (240 V) by 1.1.

*3 : The rated output current of the drive should be equal to or greater than the motor rated current.

*4 : This value assumes a carrier frequency of 4 kHz. Increasing the carrier frequency requires a reduction in current.

*5 : When the harmonic current distortion rate is 5% or less, the maximum output voltage is calculated by multiplying input power voltage by 0.87. You must also change the parameter from the default setting.

400 V Class

Model CIMR-U: 4A		0011	0014	0021	0027	0034	0040	0052	0065	0077	0096	0124	0156	0180	0216	0240	0302	0361	0414	0477	0590	0720	0900	0930		
Rated Input/Output	Rated Input	ND	10	13	19	25	31	36	47	59	70	87	113	142	164	197	218	275	329	377	Available soon.					
	Current* ¹	A	8.7	10	13	19	25	31	36	47	59	70	87	113	142	164	197	218	275	329						
	Rated Input	ND	9	12	17	22	28	33	43	54	64	80	103	130	150	180	200	251	300	344						
	Capacity* ²	kVA	8	9	12	17	22	28	33	43	54	64	80	103	130	150	180	200	251	300						
	Rated Output	ND	11	14	21	27	34	40	52	65	77	96	124	156	180	216	240	302	361	414						
	Current* ^{3*4}	A	9.6	11	14	21	27	34	40	52	65	77	96	124	156	180	216	240	302	361						
Overload Tolerance		HD Rating: 150% of rated output current for 60 s, ND Rating: 120% of rated output current for 60 s (Derating may be required for repetitive loads)																								
Carrier Frequency		4 kHz (User adjustable up to 10 kHz. Derating may be required.)																								
Max. Output Voltage		Depends on input voltage																								
Max. Output Frequency		400 Hz																								
Power	Rated Voltage/Rated Frequency	Three-phase AC power supply: 380 to 480 Vac 50/60 Hz																								
	Allowable Voltage Fluctuation	-15% to +10%																								
	Allowable Frequency Fluctuation	±3% (Frequency fluctuation rate: 1 Hz/100 ms or less)																								
	Allowable Power Voltage Imbalance between Phases	less than 2%																								
	Harmonic Current Distortion Rate* ⁵	5% or less (IEEE 519)																								
Input Power Factor		0.98 or more (for rated load)																								

*1 : Assumes operation at the rated output current. This value may fluctuate based on the power supply side impedance, as well as the input current, power supply transformer, and wiring conditions.

*2 : The rated input capacity is calculated by multiplying the power line voltage (480 V) by 1.1.

*3 : The rated output current of the drive should be equal to or greater than the motor rated current.

*4 : This value assumes a carrier frequency of 4 kHz. Increasing the carrier frequency requires a reduction in current.

*5 : When the harmonic current distortion rate is 5% or less, the maximum output voltage is calculated by multiplying input power voltage by 0.87. You must also change the parameter from the default setting.



Common Specifications

Item	Specifications	
Control Characteristics	Control Method	V/f Control, V/f Control with PG, Open Loop Vector Control, Closed Loop Vector Control, Open Loop Vector Control for PM, Advanced Open Loop Vector Control for PM, Closed Loop Vector Control for PM
	Frequency Control Range	0.01 to 400 Hz
	Frequency Accuracy (Temperature Fluctuation)	Digital reference: within $\pm 0.01\%$ of the max. output frequency (-10 to +40°C) Analog reference: within $\pm 0.1\%$ of the max. output frequency (25 \pm 10°C)
	Frequency Setting Resolution	Digital reference: 0.01 Hz, Analog reference: 0.03 Hz / 60 Hz (11 bit)
	Output Frequency Resolution	0.001 Hz
	Frequency Setting Resolution	Main frequency reference: -10 to +10 Vdc, 0 to 10 Vdc (20 k Ω), 4 to 20 mA (250 Ω), 0 to 20 mA (250 Ω) Main speed reference: Pulse train input (max. 32 kHz)
	Starting Torque	V/f Control 150%/3 Hz V/f Control with PG 150%/3 Hz Open Loop Vector Control 200%/0.3 Hz*1 Closed Loop Vector Control 200%/0 min ⁻¹ *1 Open Loop Vector Control for PM 100%/5% Speed Advanced Open Loop Vector Control for PM 200%/0 min ⁻¹ *1 Closed Loop Vector Control for PM 200%/0 min ⁻¹ *1
	Speed Control Range	V/f Control 1: 40 V/f Control with PG 1: 40 Open Loop Vector Control 1: 200 Closed Loop Vector Control 1: 1500 Open Loop Vector Control for PM 1: 20 Advanced Open Loop Vector Control for PM 1: 100 Closed Loop Vector Control for PM 1: 1500
	Speed Control Accuracy	$\pm 0.2\%$ in Open Loop Vector Control (25 \pm 10°C), $\pm 0.02\%$ in Closed Loop Vector Control (25 \pm 10°C)*2
	Speed Response	10 Hz in Open Loop Vector Control (25 \pm 10°C), 250 Hz in Closed Loop Vector Control (25 \pm 10°C)*3 (excludes temperature fluctuation when performing Rotational Auto-Tuning)
	Torque Limit	Parameters setting allow separate limits in four quadrants (available in OLV, CLV, AOLV/PM, CLV/PM)
	Accel/Decel Time	0.00 to 6000.0 s (4 selectable combinations of independent acceleration and deceleration settings)
	Braking Torque	Same value as overload tolerance
	V/f Characteristics	User-selected programs and V/f preset patterns possible
Protection Function	Main Control Functions	Torque Control, Droop Control, Speed/Torque Control switch, Feed Forward Control, Zero Servo Control, Momentary Power Loss Ride-Thru, Speed Search, Synchronous Transfer with Commercial Power Supply, Overtorque detection, torque limit, 17 Step Speed (max.), accel/dec time switch, S-curve accel/dec, 3-wire sequence, Auto-Tuning (rotational, stationary), Dwell, cooling fan on/off switch, slip compensation, torque compensation, Frequency Jump, Upper/lower limits for frequency reference, DC Injection Braking at start and stop, High Slip Braking, PID control (with Sleep function), Energy Saving Control, MEMOBUS comm. (RS-485/422, max. 115.2 kbps), Fault Restart, Application Presets, DriveWorksEZ (customized functions), Removable Terminal Block with Parameter Backup, Online Tuning, Overexcitation Deceleration, Inertia (ASR) Tuning, High Frequency Injection, etc.
	Power Supply Regeneration	Available
	Motor Protection	Motor overheat protection based on output current
	Momentary Overcurrent Protection	Stops over 200% rated output current (Heavy Duty)
	Overload Protection	Drive stops after 60 s at 150% of rated output current (when set for Heavy Duty performance)*4
	Input Power Overvoltage Protection	200 V class: Stops when input voltage exceeds approx. 315 V, 400 V class: Stops when input voltage exceeds approx. 630 V
	Input Power Undervoltage Protection	200 V class: Stops when input voltage falls below approx. 150 V, 400 V class: Stops when input voltage falls below approx. 300 V
	Momentary Power Loss Ride-Thru	Immediately stop after 2 ms or longer power loss.*5 Continuous operation during power up to 2 s (standard).*6
	Heatsink Overheat Protection	Thermistor
	Stall Prevention	Stall prevention during acceleration/deceleration and constant speed operation
	Ground Fault Protection	Protection by electronic circuit*7
	Charge LCD	Charge LED remains lit until DC bus has fallen below approx. 50 V
	Environment	Area of Use
Ambient Temperature		-10 to +50°C (open-chassis), -10 to +40°C (NEMA Type 1)
Humidity		95% RH or less (no condensation)
Storage Temperature		-20 to +60°C (short-term temperature during transportation)
Altitude		Up to 1000 meters*8
Shock	10 Hz to 20 Hz, 9.8 m/s ² 20 Hz to 55 Hz, CIMR-UA□A0034 to 2A0077, 4A0011 to 4A0077: 5.9 m/s ² 20 Hz to 55 Hz, CIMR-UA□A0096 to 2A0216, 4A0096 to 4A0414: 2.0 m/s ²	
Standards Compliance	• UL508C • IEC/EN61800-3, IEC/EN61800-5-1 • Two Safe Disable inputs and 1EDM output according to ISO/EN13849-1 Cat.3 Plc, IEC/EN61508 SIL3	
Protection Design	IP00 open-chassis, IP20 NEMA Type 1 enclosure*9	

*1 : Current derating is required.

*2 : Speed control accuracy may vary slightly depending on installation conditions or motor used. Contact Yaskawa for consultation.

*3 : When the Speed Response Selection (C5-29) is set to 1.

*4 : Overload protection may be triggered when operating with 150% of the rated output current if the output frequency is less than 6 Hz.

*5 : May be shorter due to load conditions and motor speed.

*6 : A separate Momentary Power Loss Ride-Thru Unit is required for the drives if the application needs to continue running during a momentary power loss up to 2 s.

*7 : Protection may not be provided under the following conditions as the motor windings are grounded internally during run:

- Low resistance to ground from the motor cable or terminal block.
- Drive already has a short-circuit when the power is turned on.

*8 : Up to 3000 m with output current and voltage derating. Refer to Technical Manual for details.

*9 : Removing the cover of changes the drive's NEMA Type 1 rating to IP20.

Standard Connection Diagram CIMR-UA2A0028

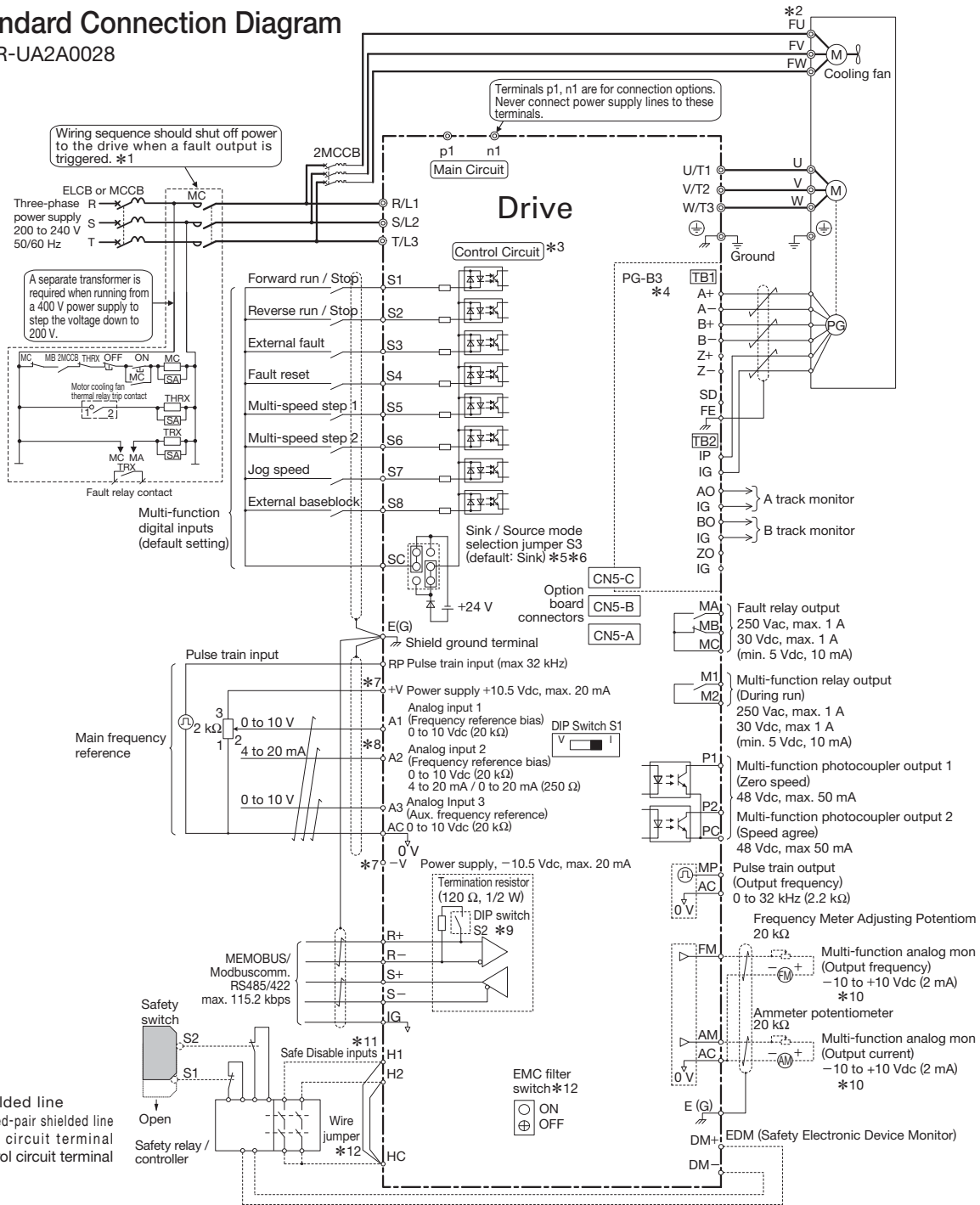

- * 1 : Note that if the drive is set to trigger a fault output whenever the fault restart function is activated (L5-02 = 1), then a sequence to interrupt power when a fault occurs will result in shutting off the power to the drive as the drive attempts to restart itself. The default setting for L5-02 is 0 (fault output not active during restart attempt).
- * 2 : Self-cooling motors do not require wiring that would be necessary with motors using a cooling fan.
- * 3 : For control modes that do not use a motor speed feedback signal, PG option card wiring is not necessary.
- * 4 : This figure shows an example of a sequence input to S1 through S8 using a non-powered relay or an NPN transistor. Use jumper S3 to select the sink mode for the use of an internal power supply or the source mode for the use of an external power supply.
- * 5 : An external power supply cannot be used in sink mode (+24 V common) and an internal power supply cannot be used in source mode. Refer to Technical Manual for details.
- * 6 : The maximum output current capacity for the +V and -V terminals on the control circuit is 20 mA. Never short terminals +V, -V, and AC, as this can cause erroneous operation or damage the drive.
- * 7 : Set DIP switch S1 to select between a voltage or current input signal to terminal A2. The default setting is for current input.
- * 8 : Enable the termination resistor in the last drive in a MEMOBUS/Modbus network by setting DIP switch S2 to the ON position.
- * 9 : Monitor outputs work with devices such as analog frequency meters, ammeters, voltmeters, and wattmeters. Do not use these outputs in a feedback loop.
- * 10 : The sink/source setting for the Safe Disable input is the same as with the sequence input. Jumper S3 has the drive set for an external power supply. When not using the Safe Disable input feature, remove the jumper shorting the input and connect an external power supply.
- * 11 : Disconnect the wire jumper between H1 - HC and H2 - HC when utilizing the Safe Disable input.
- * 12 : Models CIMR-U...E...W... have EMC filter switches.



Terminal Functions

Main Circuit Terminals

Max. Applicable Motor Capacity indicates Heavy Duty

Voltage	200 V	400 V
Model CIMR-UA	2A0028 to 2A0248	4A0011 to 4A0930
R/L1, S/L2, T/L3	Main circuit input power supply	
U/T1, V/T2, W/T3	Drive output	
p1, n1	Momentary power loss recovery unit input	
⊕	Ground terminal (100 Ω or less)	Ground terminal (10 Ω or less)

Control Circuit Input Terminals (200 V/400 V Class)

Terminal Type	Terminal	Signal Function	Description	Signal Level
Multi-Function Digital Input	S1	Multi-function input selection 1	Closed: Forward run (default) Open: Stop (default)	Photocoupler 24 Vdc, 8 mA
	S2	Multi-function input selection 2	Closed: Reverse run (default) Open: Stop (default)	
	S3	Multi-function input selection 3	External fault, N.O. (default)	
	S4	Multi-function input selection 4	Fault reset (default)	
	S5	Multi-function input selection 5	Multi-step speed reference 1 (default)	
	S6	Multi-function input selection 6	Multi-step speed reference 2 (default)	
	S7	Multi-function input selection 7	Jog frequency (default)	
	S8	Multi-function input selection 8	Closed: External baseblock	
	SC	Multi-function input selection common	Multi-function input selection common	
Main Frequency Reference Input	RP	Multi-function pulse train input	Frequency reference (default) (H6-01 = 0)	0 to 32 kHz (3 kΩ)
	+V	Setting power supply	+10.5 V power supply for analog reference (20 mA max.)	
	-V	Setting power supply	-10.5 V power supply for analog reference (20 mA max.)	
	A1	Multi-function analog input 1	-10 to +10 Vdc for -100 to +100%, 0 to 10 Vdc for 0 to 100% (impedance 20 kΩ), Main frequency reference (default)	
	A2	Multi-function analog input 2	DIP switch S1 sets the terminal for a voltage or current input signal -10 to +10 Vdc for -100 to +100%, 0 to 10 Vdc for 0 to 100% (impedance 20 kΩ) 4 to 20 mA for 0 to 100%, 0 to 20 mA for 0 to 100% (impedance 250 Ω) Added to the reference value of the analog frequency for the main frequency reference (default)	
	A3	Multi-function analog input 3	-10 to +10 Vdc for -100 to +100%, 0 to 10 Vdc for 0 to 100% (impedance 20 kΩ) Auxiliary frequency reference (default)	
	AC	Frequency reference common	0 V	
	E(G)	Connection to wire shielding and option card ground wire	-	
Multi-Function Photocoupler Output	P1	Multi-function photocoupler output (1)	Zero speed (default)	48 Vdc or less, 2 to 50 mA Photocoupler output*1
	P2	Multi-function photocoupler output (2)	Speed agree (default)	
	PC	Photocoupler output common	-	
Fault Relay Output	MA	N.O. output	Closed: Fault	Relay output 250 Vac or less, 10 mA to 1 A. 30 Vdc or less, 10 mA to 1 A Minimum load: 5 Vdc, 10 mA
	MB	N.C. output	Open: Fault	
	MC	Digital output common	-	
Multi-Function Digital Output*2	M1	Multi-function digital output	During run (default)	10 mA to 1 A Minimum load: 5 Vdc, 10 mA
	M2		Closed: During run	
Monitor Output	MP	Pulse train input	Output frequency (default) (H6-06 = 102)	0 to 32 kHz (2.2 kΩ)
	FM	Multi-function analog monitor (1)	Output frequency (default)	0 to 10 Vdc for 0 to 100%
	AM	Multi-function analog monitor (2)	Output current (default)	-10 to +10 Vdc for -100 to +100%
	AC	Analog common	0 V	Resolution: 1/1000
Safety Input	H1	Safety input 1	24 Vdc 8 mA. One or both open: Output disabled. Both closed: Normal operation. Internal impedance 3.3 kΩ, switching time at least 1 ms.	
	H2	Safety input 2		
	HC	Safety input common	Safety input common	
Safety Monitor Output	DM+	Safety monitor output	Outputs status of Safe Disable function.	48 Vdc or less, 50 mA or less
	DM-	Safety monitor output common	Closed when both Safe Disable channels are closed.	

*1 : Connect a flywheel diode as shown below when driving a reactive load such as a relay coil. Diode must be rated higher than the circuit voltage.

*2 : Refrain from assigning functions to terminals M1 and M2 that involve frequent switching, as doing so may shorten relay performance life. Switching life is estimated at 200,000 times (assumes 1 A, resistive load).

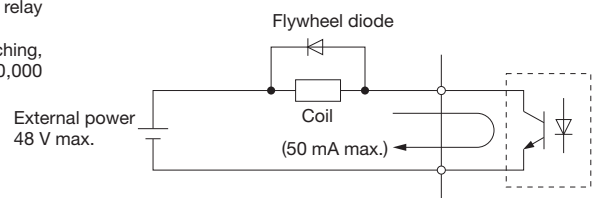

Serial Communication Terminals (200 V/400 V Class)

Classification	Terminal	Signal Function	Description	Signal Level
RS-485/RS-422 Communication	R+	Communications input (+)	MEMOBUS/Modbus communications: Use a RS-485 or RS-422 cable to connect the drive.	RS-422/RS-485 MEMOBUS/Modbus communications protocol 115.2 kbps (max.)
	R-	Communications input (-)		
	S+	Communications output (+)		
	S-	Communications output (-)		
	IG	Shield ground		

■ Open-Chassis (IP00)

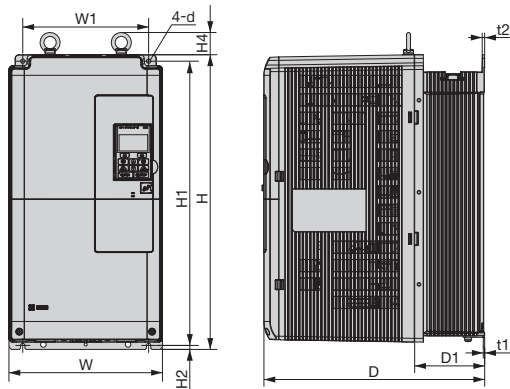

Figure 1

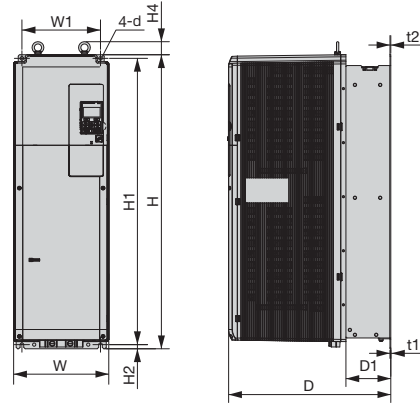

Figure 2

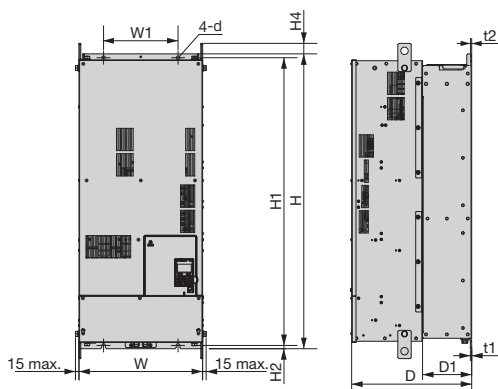

Figure 3

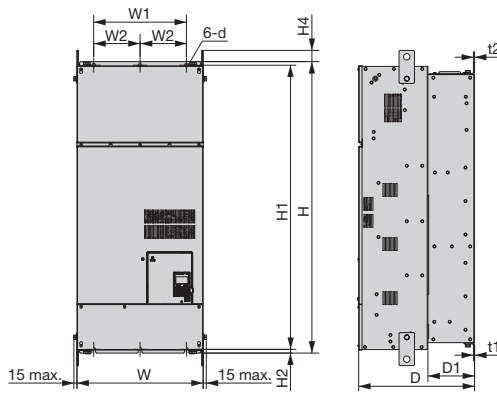

Figure 4

200 V Class

Model CIMR-U: 2A□□□□□□□□	Figure	Dimensions (mm)											Weight(kg)		Cooling	
		W	H	D	W1	W2	H1	H2	H4	D1	t1	t2	d	CIMR-U: 2A□□ CIMR-U: 2P□□		CIMR-U: 2E□□ CIMR-U: 2W□□
0028	1	250	480	360	205	—	463	6.5	40	100	2.3	4	7	20	21	Fan cooled
0042		264	650	420	218	—	629	11.5	40	115.5	2.3	4	10	32	33	
0054														35	36	
0068														60	63	
0081	2	264	816	450	218	—	795	11.5	40	124.5	2.3	2.3	10	110	115	
0104																
0130	3	415	990	403	250	—	966	11	40	165	4.5	3.9	12	176	181	
0154																
0192	4	490	1132	450	360	180	1104	14.5	49	181	4.5	4.5	14	259	267	
0248																

400 V Class

Model CIMR-U: 4A□□□□□□□□	Figure	Dimensions (mm)											Weight(kg)		Cooling															
		W	H	D	W1	W2	H1	H2	H4	D1	t1	t2	d	CIMR-U: 4A□□ CIMR-U: 4P□□		CIMR-U: 4E□□ CIMR-U: 4W□□														
0011	1	250	480	360	205	—	463	6.5	40	100	2.3	4	7	20	21	Fan cooled														
0014																	264	650	420	218	—	629	11.5	40	115.5	2.3	4	10	32	33
0021																													35	36
0027																													60	63
0034	2	264	816	450	218	—	795	11.5	40	124.5	2.3	2.3	10	110	115															
0040																														
0052	3	415	990	403	250	—	966	11	40	165	4.5	3.9	12	176	181															
0065																														
0077	4	490	1132	450	360	180	1104	14.5	49	181	4.5	4.5	14	259	267															
0096																														
0124	4	695	1132	450	560	280	1102	14.5	65	178	4.5	4.5	14	259	267															
0156																														
0180	4	695	1132	450	560	280	1102	14.5	65	178	4.5	4.5	14	259	267															
0216																														
0240	4	695	1132	450	560	280	1102	14.5	65	178	4.5	4.5	14	259	267															
0302																														
0361	4	695	1132	450	560	280	1102	14.5	65	178	4.5	4.5	14	259	267															
0414																														
0477	4	695	1132	450	560	280	1102	14.5	65	178	4.5	4.5	14	259	267															
0590																														
0720	4	695	1132	450	560	280	1102	14.5	65	178	4.5	4.5	14	259	267															
0900																														
0930	4	695	1132	450	560	280	1102	14.5	65	178	4.5	4.5	14	259	267															
Available soon.																														



■ Enclosure Panel [NEMA Type 1]

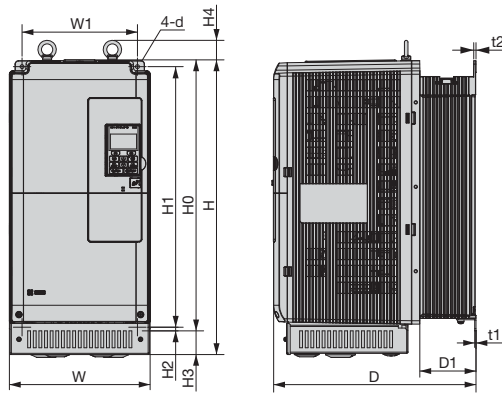

Figure 1

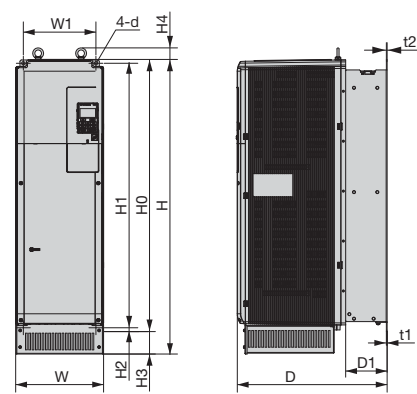

Figure 2

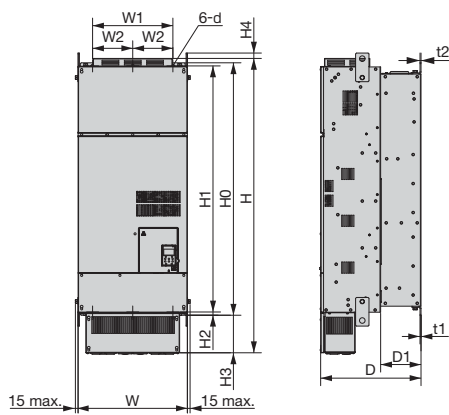

Figure 3

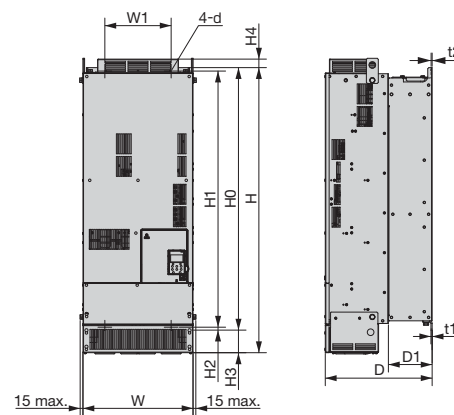

Figure 4

200 V Class

Model CIMR-U _{2A}	Figure	Dimensions (mm)														Weight(kg)		Cooling
		W	H	D	W1	W2	H0	H1	H2	H3	H4	D1	t1	t2	d	CIMR-U _{2A}	CIMR-U _{2E}	
0028	1	250	524	360	205	-	480	463	6.5	42	40	100	2.3	4	7	21.5	22.5	Fan cooled
0042																34	35	
0054																37	38	
0068																		
0081																		
0104	2	264	885	450	218	-	816	795	11.5	68	40	124.5	2.3	2.3	10	62	65	
0130																		
0154	3	415	1107	403	250	-	990	966	11	85	8	165	4.5	3.9	12	113	118	
0192																		
0248	4	490	1320	450	360	180	1132	1104	14.5	169	29	181	4.5	4.5	14	180	185	

400 V Class

Model CIMR-U _{4A}	Figure	Dimensions (mm)														Weight(kg)		Cooling
		W	H	D	W1	W2	H0	H1	H2	H3	H4	D1	t1	t2	d	CIMR-U _{4A}	CIMR-U _{4E}	
0011	1	250	524	360	205	-	480	463	6.5	42	40	100	2.3	4	7	21.5	22.5	Fan cooled
0014																		
0021																		
0027																		
0034																		
0040	2	264	705	420	218	-	650	629	11.5	54	40	115.5	2.3	4	10	34	35	
0052																		
0065																		
0077																		
0096																		
0124	3	415	1107	403	250	-	990	966	11	85	8	165	4.5	3.9	12	113	118	
0156																		
0180																		
0216																		
0240																		4
0302																		
0361																		
0414																		
0477																		
0590	Available soon.																	
0720																		
0900																		
0930																		

Features
Product Lineup
Model Selection
Parameter List
Basic Instructions
Standard Specifications
Standard Connection Diagram
Dimensions
Fully-Enclosed Design
Peripheral Devices and Options
Application Notes
Global Service Network

The Open-Chassis type drive can be installed in a fully-enclosed panel.

An open-chassis model in a protective enclosure with the heatsink inside the panel allows for intake air temperature up to 50°C. The heatsink can alternatively be mounted outside the enclosure panel, thus reducing the amount of heat inside the panel and allowing for a more compact set up. Current derating or other steps to ensure cooling are required at 50°C.

• Cooling Design for Fully-Closed Enclosure Panel

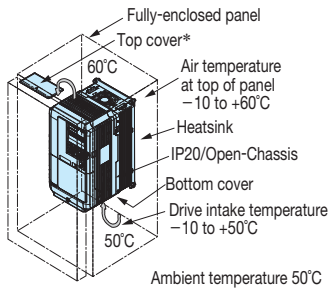

• Mounting the External Heatsink

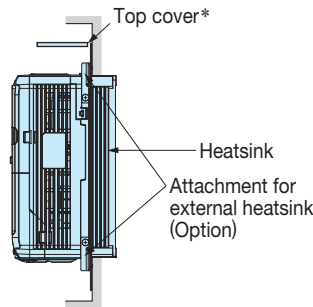

*: Enclosure panel can be installed with the top and bottom covers removed.

• Ventilation Space

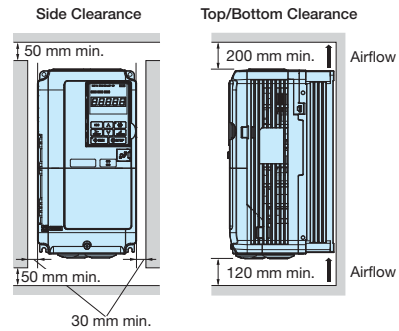

If you use the Matrix Converter installed in a panel, provide sufficient space for the suspension fittings on the Unit and for wiring the main circuits.

Drive Watts Loss Data

200 V Class Normal Duty Ratings

Model Number		0028	0042	0054	0068	0081	0104	0130	0154	0192	0248
CIMR-U: 2A											
Rated Output Current A		28	42	54	68	81	104	130	154	192	248
Heat Loss	Heatsink W	659	854	1037	1295	1420	1696	2157	2441	3064	3785
	Internal W	103	168	195	225	238	282	341	366	447	578
	Total Heat Loss W	762	1022	1232	1520	1658	1978	2498	2807	3511	4363

400 V Class Normal Duty Ratings

Model Number		0011	0014	0021	0027	0034	0040	0052	0065	0077	0096	0124	0156	0180	0216	0240	0302	0361	0414	0477	0590	0720	0900	0930
CIMR-U: 4A																								
Rated Output Current A		11	14	21	27	34	40	52	65	77	96	124	156	180	216	240	302	361	414	Available soon.				
Heat Loss	Heatsink W	452	459	641	675	798	877	1109	1369	1479	1715	2256	2857	3316	3720	3897	5202	5434	6444					
	Internal W	80	79	105	106	124	174	209	240	251	290	362	421	482	587	600	857	863	1012					
	Total Heat Loss W	532	538	746	781	922	1051	1318	1609	1730	2005	2618	3278	3798	4307	4497	6059	6297	7456					

200 V Class Heavy Duty Ratings

Model Number		0028	0042	0054	0068	0081	0104	0130	0154	0192	0248
CIMR-U: 2A											
Rated Output Current A		22	28	42	54	68	81	104	130	154	192
Heat Loss	Heatsink W	543	586	808	1016	1181	1313	1673	2037	2400	2815
	Internal W	91	138	168	190	208	234	280	318	366	460
	Total Heat Loss W	634	724	976	1206	1389	1547	1953	2355	2766	3275

400 V Class Heavy Duty Ratings

Model Number		0011	0014	0021	0027	0034	0040	0052	0065	0077	0096	0124	0156	0180	0216	0240	0302	0361	0414	0477	0590	0720	0900	0930
CIMR-U: 4A																								
Rated Output Current A		9.6	11	14	21	27	34	40	52	65	77	96	124	156	180	216	240	302	361	Available soon.				
Heat Loss	Heatsink W	415	372	438	549	658	693	855	1087	1238	1373	1693	2242	2833	3035	3498	3867	4384	5563					
	Internal W	76	70	80	93	107	150	178	204	220	247	290	343	421	503	551	689	735	902					
	Total Heat Loss W	491	442	518	642	765	843	1033	1291	1458	1620	1983	2585	3254	3538	4049	4556	5119	6465					



● Attachment for External Heatsink (Available soon)

● Panel Modification for External Heatsink (Available soon)

Features

Product Lineup

Model Selection

Parameter List

Basic Instructions

Standard Specifications

Standard Connection Diagram

Dimensions

Fully-Enclosed Design

Peripheral Devices and Options

Application Notes

Global Service Network

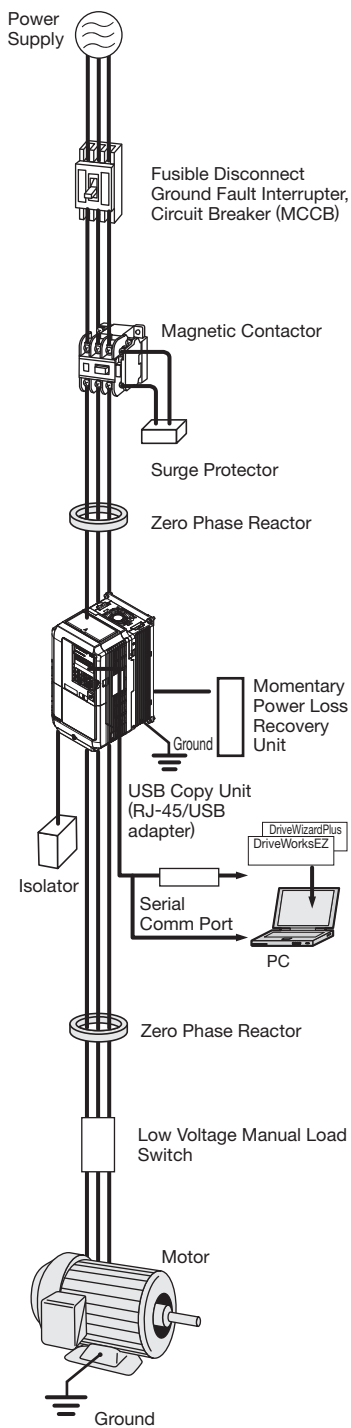

Name	Purpose	Model, Manufacturer	Page	
Ground Fault Interrupter (GFI)	Always install a GFI on the power-supply side to protect the power supply system and to prevent an overload at the occurrence of shortcircuit, and to protect the drive from ground faults that could result in electric shock or fire. Note: When a GFI is installed for the upper power supply system, an MCCB can be used instead of a GFI. (Choose a GFI designed to minimize harmonics specifically for AC drives. Use one GFI per drive, each with a current rating of at least 30 mA.)	NV series* ¹ by Mitsubishi Electric Corporation NS Series* ¹ by Schneider Electric	32	
Circuit Breaker	Always install a circuit breaker on the power-supply side to protect the power supply system and to prevent an overload at the occurrence of a short-circuit.	NF series* ¹ by Mitsubishi Electric Corporation	32	
Magnetic Contactor	Interrupts the power supply to the drive. In addition to protecting drive circuitry, a magnetic contactor also prevents damage to a braking resistor if used.	SC series* ¹ by Fuji Electric FA Components & Systems Co., Ltd.	33	
Surge Protector	Absorbs the voltage surge from switching of electromagnetic contactors and control relays. Install a surge protector to the magnetic contactors and control relays as well as magnetic valves and magnetic braking coil.	DCR2 series RFN series by Nippon Chemicon Corporation	33	
Zero Phase Reactor	Reduces noise from the line that enters into the drive input power system. Should be installed as close as possible to the drive. Can be used on both the input and output sides.	F6045GB F11080GB F200160PB by Hitachi Metals, Ltd.	34	
Isolator	Isolates the drive I/O signal, and is effective in reducing inductive noise.	DGP2 series	35	
USB Copy Unit (RJ-45/USB compatible plug)	· Can copy parameter settings easily and quickly to be later transferred to another drive. · Adapter for connecting the drive to the USB port of a PC.	JVOP-181	37	
PC cable	Connect the drive and PC when using DriveWizard Puls or DriveWorksEZ. The cable length must be 3 m or less.	Commercially available USB2.0 A/B cable.	37	
LED Operator	For easier operation when using the optional LED operator. Allows for remote operation. Includes a Copy function for saving drive settings.	JVOP-182	37	
LCD Operator Extension Cable	Cable for connecting the LCD operator.	WV001: 1 m WV003: 3 m	36	
Momentary Power Loss Recovery Unit	Ensures continuous drive operation for a power loss of up to 2 s.	P0010 Type (200 V class) P0020 Type (400 V class)	35	
Frequency Meter, Current Meter	Allows the user to set and monitor the frequency, current, and voltage using an external device.	DCF-6A	38	
Variable Resistor Board (20 kΩ)		ETX3120	38	
Frequency Setting Potentiometer (2 kΩ)		RH000739	38	
Frequency Meter Adjusting Potentiometer (20 kΩ)		RH000850	38	
Control Dial for Frequency Setting Potentiometer		CM-3S	38	
Output Voltage Meter		SCF-12NH	39	
Voltage Transformer		UPN-B	39	
Attachment for External Heatsink		Required for heatsink installation. Current derating may be needed when using a heatsink.	—	*2
Low Voltage Manual Load Switch		Prevents shock from the voltage created on the terminals board from a coasting synchronous motor.	AICUT, LB series* ¹ by Aichi Electric Works Co., Ltd	—

*1 : Recommended by Yaskawa. Contact the manufacturer in question for availability and specifications of non-Yaskawa products.

*2 : Available soon.



Option Cards

RoHS compliant

Type	Name	Model	Function	Manual No.
Speed Reference Card	Analog Input	AI-A3	Enables high-precision and high-resolution analog speed reference setting. · Input signal level: -10 to +10 Vdc (20 k Ω) 4 to 20 mA (250 Ω) · Input channels : 3 channels, DIP switch for input voltage/ input current selection · Input resolution : Input voltage 13 bit signed (1/8192) Input current 1/4096	TOBPC73060038
	Digital Input	DI-A3	Enables 16-bit digital speed reference setting. · Input signal: 16 bit binary, 2 digit BCD + sign signal + set signal · Input voltage: 24 V (isolated) · Input current: 8 mA User-set: 8 bit, 12 bit, 16 bit	TOBPC73060039
Communications Option Card*1	MECHATROLINK-II Interface	SI-T3*3	Used for running or stopping the drive, setting or referencing parameters, and monitoring output frequency, output current, or similar items through MECHATROLINK-II communication with the host controller.	TOBPC73060050 SIEPC73060050
	MECHATROLINK-III Interface	SI-ET3	Used for running or stopping the drive, setting or referencing parameters, and monitoring output frequency, output current, or similar items through MECHATROLINK-III communication with the host controller.	-
	CC-Link Interface	SI-C3	Used for running or stopping the drive, setting or referencing parameters, and monitoring output frequency, output current, or similar items through CC-Link communication with the host controller.	TOBPC73060044 SIEPC73060044
	DeviceNet Interface	SI-N3*3	Used for running or stopping the drive, setting or referencing parameters, and monitoring output frequency, output current, or similar items through DeviceNet communication with the host controller.	TOBPC73060043 SIEPC73060043
	LONWORKS Interface	SI-W3	Used for HVAC control, running or stopping the drive, setting or referencing parameters, and monitoring output current, watt-hours, or similar items through LONWORKS communications with the host controller.	TOBPC73060056 SIEPC73060056
	PROFIBUS-DP Interface	SI-P3	Used for running or stopping the drive, setting or referencing parameters, and monitoring output frequency, output current, or similar items through CANopen communication with the host controller.	TOBPC73060042 SIEPC73060042
	CANopen Interface	SI-S3	Used for running or stopping the drive, setting or referencing parameters, and monitoring output frequency, output current, or similar items through CANopen communication with the host controller.	TOBPC73060045 SIEPC73060045
	Monitor Option Card	Analog Monitor	AO-A3	Outputs analog signal for monitoring drive output state (output freq., output current etc.). · Output resolution: 11 bit signed (1/2048) · Output voltage: -10 to +10 Vdc (non-isolated) · Terminals: 2 analog outputs
Digital Output		DO-A3	Outputs isolated type digital signal for monitoring drive run state (alarm signal, zero speed detection, etc.) · Terminals: 6 photocoupler outputs (48 V, 50 mA or less) 2 relay contact outputs (250 Vac, 1 A or less 30 Vdc, 1 A or less)	TOBPC73060041
PG Speed Controller Card*2	Complimentary Type PG	PG-B3	For control modes requiring a PG encoder for motor feedback. · Phase A, B, and Z pulse (3-phase) inputs (complimentary type) · Max. input frequency: 50 kHz · Pulse monitor output: Open collector, 24 V, max. current 30 mA · Power supply output for PG: 12 V, max. current 200 mA Note: Not available in Advanced Open Loop Vector for PM.	TOBPC73060036
	Line Driver PG	PG-X3	For control modes requiring a PG encoder for motor feedback. · Phase A, B, and Z pulse (differential pulse) inputs (RS-422) · Max. input frequency: 300 kHz · Pulse monitor output: RS-422 · Power supply output for PG: 5 V or 12 V, max. current 200 mA	TOBPC73060037
	EnDat Encoder Interface (EnDat, HIPERFACE)	PG-F3	For speed feedback input by connecting a motor encoder Encoder type: EnDat 2.1/01, EnDat 2.2/01, and EnDat 2.2/22(HEIDENHAIN), HIPERFACE (SICK STEGMANN) Maximum input frequency: 20 kHz Wiring length: 20 m max. for the encoder, 30 m max. for the pulse monitor Pulse monitor: Matches RS-422 level [Encoder power supply: 5 V, max current 330 mA or 8 V, max current 150 mA]	TOBPC73060051
	Resolver Interface for TS2640N321E64	PG-RT3	For control modes requiring a PG encoder for motor feedback. Can be connected to the TS2640N321E64 resolver made by Tamagawa Seiki Co., Ltd. and electrically compatible resolvers. The representative electrical characteristics of the TS2640N321E64 are as follows. · Input voltage: 7 Vac rms 10 kHz · Transformation ratio: 0.5 \pm 5% · maximum input current: 100 mArms	TOBPC73060053

* 1 : Each communication option card requires a separate configuration file to link to the network.

* 2 : PG speed controller card is required for PG control.

* 3 : Available soon.

● Ground Fault Interrupter, Circuit Breaker

Base device selection on motor capacity.



Ground Fault Interrupter
[Mitsubishi Electric Corporation]



Circuit Breaker
[Mitsubishi Electric Corporation]

200 V Class

Motor Capacity (kW)	Ground Fault Interrupter			Ground Fault Interrupter		
	Model	Rated Current (A)	Interrupt Capacity (kA) Icu/Ics*	Model	Rated Current (A)	Interrupt Capacity (kA) Icu/Ics*
5.5	NV32-SW	30	10/4	NF32	30	5/2
7.5	NV63-SW	40	15/8	NF63	40	7.5/4
11	NV63-SW	50	15/8	NF63	50	7.5/4
15	NV125-SW	75	50/25	NF125	75	30/15
18.5	NV125-SW	75	50/25	NF125	75	30/15
22	NV125-SW	100	50/25	NF125	100	30/15
30	NV250-SW	125	50/25	NF250	125	35/18
37	NV250-SW	150	50/25	NF250	150	30/18
45	NV250-SW	175	50/25	NF250	175	30/18
55	NV250-SW	225	50/25	NF250	225	35/18
75	NV400-SW	300	85/85	NF400	300	50/25

* : Icu : Rated ultimate short-circuit breaking capacity Ics : Rated service short-circuit breaking capacity

400 V Class

Motor Capacity (kW)	Ground Fault Interrupter			Ground Fault Interrupter		
	Model	Rated Current (A)	Interrupt Capacity (kA) Icu/Ics*	Model	Rated Current (A)	Interrupt Capacity (kA) Icu/Ics*
2.2	NV32-SW	10	5/2	NF32	10	2.5/1
3.7	NV32-SW	10	5/2	NF32	10	2.5/1
5.5	NV32-SW	15	5/2	NF32	15	2.5/1
7.5	NV32-SW	20	5/2	NF32	20	2.5/1
11	NV32-SW	30	5/2	NF32	30	2.5/1
15	NV32-SW	30	5/2	NF32	30	2.5/1
18.5	NV63-SW	40	7.5/4	NF63	40	2.5/1
22	NV63-SW	50	7.5/4	NF63	50	2.5/1
30	NV125-SW	60	25/13	NF125	60	10/5
37	NV125-SW	75	25/13	NF125	75	10/5
45	NV125-SW	100	25/13	NF125	100	10/5
55	NV250-SW	125	25/13	NF250	125	18/9
75	NV250-SW	150	25/13	NF250	150	18/9
90	NV250-SW	175	25/13	NF250	175	18/9
110	NV250-SW	225	25/13	NF250	225	18/9
132	NV400-SW	300	42/42	NF400	300	25/13
160	NV400-SW	350	42/42	NF400	350	25/13
185	NV400-SW	400	42/42	NF400	400	25/13
220	NV630-SW	500	42/42	NF630	500	36/18
260	NV630-SW	500	42/42	NF630	500	36/18
300	NV630-SW	630	42/42	NF630	630	36/18
375	NV800-SEW	800	42/42	NF800	800	36/18
450	NV1000-SB	1000	85	NF1000	1000	85/43
500	NV1000-SB	1000	85	NF1000	1000	85/43

* : Icu : Rated ultimate short-circuit breaking capacity Ics : Rated service short-circuit breaking capacity



Magnetic Contactor

Base device selection on motor capacity.

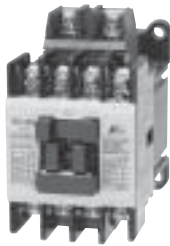

Magnetic Contactor
[Fuji Electric FA Components & Systems Co., Ltd]

200 V Class

Motor Capacity (kW)	Utilization Category AC-1*1		Utilization Category AC-3*1	
	Model	Rated Current (A)	Model	Rated Current (A)
5.5	SC-4-0	25	SC-N1	26
7.5	SC-4-1	32	SC-N2	35
11	SC-N1	50	SC-N2S	50
15	SC-N2	60	SC-N3	65
18.5	SC-N2S	80	SC-N4	80
22	SC-N2S	80	SC-N4	80
30	SC-N4	135	SC-N6	125
37	SC-N4	135	SC-N6	125
45	SC-N7	200	SC-N7	152
55	SC-N7	200	SC-N7	152
75	SC-N8	260	SC-N8	180

Wiring a Magnetic Contactor in Parallel

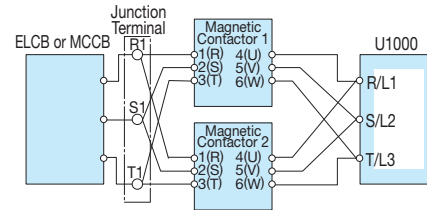

Note: When wiring contactors in parallel, make sure wiring lengths are the same to keep current flow even to the relay terminals.

400 V Class

Motor Capacity (kW)	Utilization Category AC-1*1		Utilization Category AC-3*1	
	Model	Rated Current (A)	Model	Rated Current (A)
3.7	SC-03	20	SC-0	9
5.5	SC-03	20	SC-4-0	13
7.5	SC-03	20	SC-4-1	17
11	SC-4-0	25	SC-N1	25
15	SC-4-1	32	SC-N2	32
18.5	SC-N1	50	SC-N2S	48
22	SC-N1	50	SC-N2S	48
30	SC-N2	60	SC-N3	65
37	SC-N2S	80	SC-N4	80
45	SC-N3	100	SC-N5A	90
55	SC-N3	100	SC-N6	110
75	SC-N4	135	SC-N7	150
90	SC-N7	200	SC-N8	180
110	SC-N7	200	SC-N10	220
132	SC-N8	260	SC-N11	300
160	SC-N8	260	SC-N11	300
185	SC-N11	350	SC-N12	400
220	SC-N12	450	SC-N12	400
260	SC-N14	660	SC-N14	600
300	SC-N14	660	SC-N14	600
375	SC-N16	800	SC-N16	800
450	SC-N16	800	SC-N16	800
500	SC-N12 × 2*2	450*3	SC-N14 × 2*2	600*3

*1: Utilization categories for contactors according to IEC standards.

AC-1: Typical application is non-inductive or slightly inductive loads, such as a heater. Normally select AC-1.

AC-3: Typical application is squirrel cage motors: starting, switches off running motors. Select AC-3 to open the circuit during motor operation, such as for emergency stops.

*2: When two units are connected in parallel.

*3: Rated current for a single unit.

Surge Protector

Dimensions (mm)

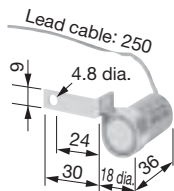

Weight: 22 g

Model: DCR2-50A22E

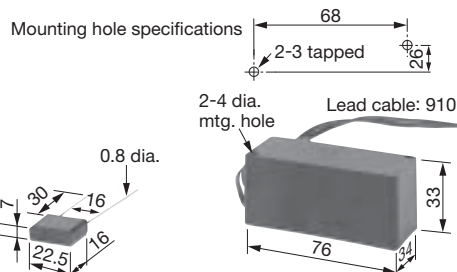

Weight: 5 g

Model: DCR2-10A25C

Weight: 150 g

Model: RFN3AL504KD

[Nippon Chemi-Con Corporation]

Product Line

Peripheral Devices		Surge Protector	Model	Specifications	Code No.
200 to 230 V		Large-Capacity Coil (other than relay)	DCR2-50A22E	220 Vac 0.5 μ F+200 Ω	C002417
200 to 240 V	Control Relay	MY2, MY3 [Omron Corporation]	DCR2-10A25C	AC 250 V 0.1 μ F+100 Ω	C002482
		MM2, MM4 [Omron Corporation]			
		HH22, HH23 [Fuji Electric FA Components & Systems Co., Ltd]	RFN3AL504KD	DC 1000 V 0.5 μ F+220 Ω	C002630
		380 to 480 V			

Zero Phase Reactor

Zero-phase reactor should match wire gauge.*

* Current values for wire gauges may vary based on electrical codes.

The table below lists selections based on Japanese electrical standards and Yaskawa's ND rating. Contact Yaskawa for questions regarding UL.

Finemet Zero-Phase Reactor to Reduce Radio Noise

Note: Finemet is a registered trademark of Hitachi Metals, Ltd.



[Hitachi Metals, Ltd.]

Connection Diagram

Compatible with the input and output side of the drive.

Example: Connection to output terminal

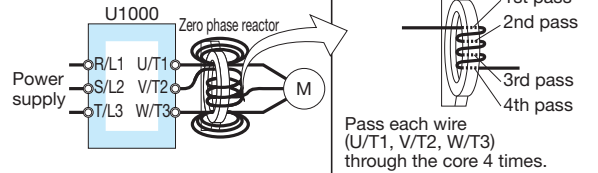
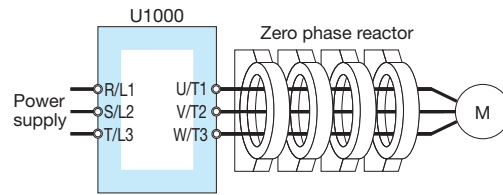

Diagram a



All wires (U/T1, V/T2, W/T3) should pass through the four cores of the reactor in series without winding.

Diagram b

Dimensions (mm)

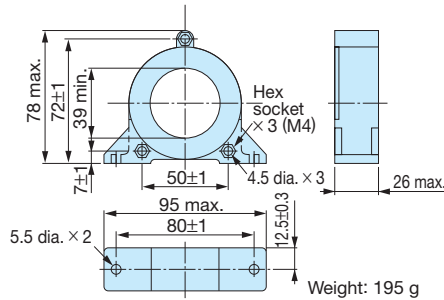

Model F6045GB

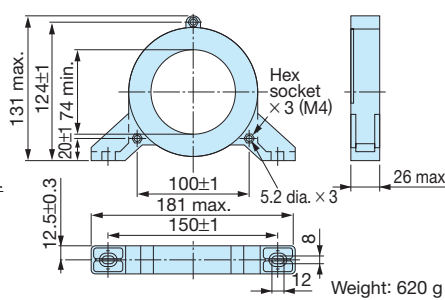

Model F11080GB

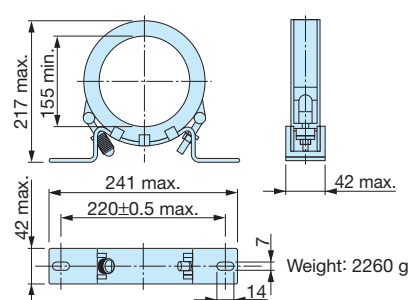

Model F200160PB

200 V Class

Model CIMR-U...2A...	U1000	Zero Phase Reactor			
	Recommended Gauge (mm ²)	Input Side/Output Side			
	Input Side/Output Side	Model	Code No.	Qty.	Diagram
0028	5.5	F6045GB	FIL001098	1	a
0042	14	F6045GB	FIL001098	4	b
0054	14	F6045GB	FIL001098	4	b
0068	22	F6045GB	FIL001098	4	b
0081	30	F6045GB	FIL001098	4	b
0104	38	F6045GB	FIL001098	4	b
0130	22X2P	F11080GB	FIL001097	4	b
0154	22X2P	F11080GB	FIL001097	4	b
0192	38X2P	F11080GB	FIL001097	4	b
0248	50X2P	F11080GB	FIL001097	4	b

400 V Class

Model CIMR-U...4A...	U1000	Zero Phase Reactor			
	Recommended Gauge (mm ²)	Input Side/Output Side			
	Input Side/Output Side	Model	Code No.	Qty.	Diagram
0011	2	F6045GB	FIL001098	1	a
0014	2	F6045GB	FIL001098	1	a
0021	3.5	F6045GB	FIL001098	1	a
0027	5.5	F6045GB	FIL001098	1	a
0034	8	F11080GB	FIL001097	1	a
0040	14	F6045GB	FIL001098	4	b
0052	14	F6045GB	FIL001098	4	b
0065	22	F6045GB	FIL001098	4	b
0077	22	F6045GB	FIL001098	4	b
0096	38	F6045GB	FIL001098	4	b
0124	22X2P	F11080GB	FIL001097	4	b
0156	22X2P	F11080GB	FIL001097	4	b
0180	30X2P	F11080GB	FIL001097	4	b
0216	38X2P	F11080GB	FIL001097	4	b
0240	50X2P	F11080GB	FIL001097	4	b
0302	80X2P	F200160PB	300-001-041	4	b
0361	100X2P	F200160PB	300-001-041	4	b
0414	125X2P	F200160PB	300-001-041	4	b
0477					
0590					
0720					
0900					
0930					

Available soon.



● Isolator (Insulation Type DC Transmission Converter)



Connection Diagram

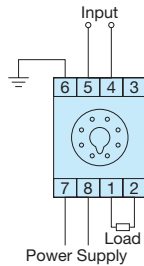

Terminal	Description
1	Output +
2	Output -
3	-
4	Input +
5	Input -
6	Grounding
7	Power Supply
8	Power Supply

Cable Length

- 4 to 20 mA: within 100 m
- 0 to 10 V: within 50 m

Dimensions (mm)

Model GP Series

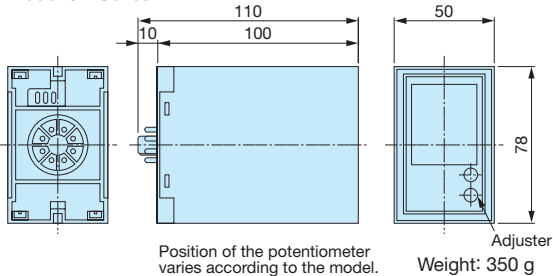

Socket

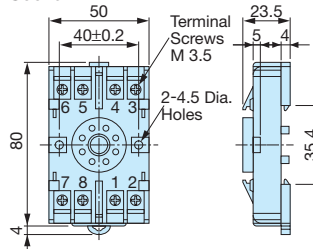

View of Socket Mounting

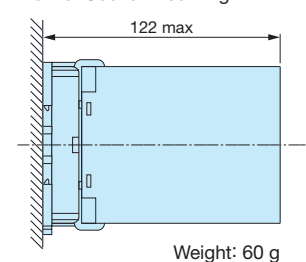

Performance

- | | |
|-----------------------------------|--|
| (1) Allowance | ±0.25% of output span (ambient temp.: 23°C) |
| (2) Temperature Fluctuation | ±0.25% of output span (at ±10°C of ambient temperature) |
| (3) Aux. Power Supply Fluctuation | ±0.1% of output span (at ±10% of aux. power supply) |
| (4) Load Resistance Fluctuation | ±0.05% of output span (in the range of load resistance) |
| (5) Output Ripple | ±0.5% P-P of output span |
| (6) Response Time | 0.5 s or less (time to settle to ±1% of final steady value) |
| (7) Withstand Voltage | 2000 Vac for 60 s (between all terminals and enclosure) |
| (8) Insulation Resistance | 20 MΩ and above (using 500 Vdc megger between each terminal and enclosure) |

Product Line

Model	Input Signal	Output Signal	Power Supply	Code No.
DGP2-4-4	0 to 10 V	0 to 10 V	100 Vac	CON 000019.25
DGP2-4-8	0 to 10 V	4 to 20 mA	100 Vac	CON 000019.26
DGP2-8-4	4 to 20 mA	0 to 10 V	100 Vac	CON 000019.35
DGP2-3-4	0 to 5 V	0 to 10 V	100 Vac	CON 000019.15
DGP3-4-4	0 to 10 V	0 to 10 V	200 Vac	CON 000020.25
DGP3-4-8	0 to 10 V	4 to 20 mA	200 Vac	CON 000020.26
DGP3-8-4	4 to 20 mA	0 to 10 V	200 Vac	CON 000020.35
DGP3-3-4	0 to 5 V	0 to 10 V	200 Vac	CON 000020.15

● Momentary Power Loss Recovery Unit



Weight: 2 kg

Connection Diagram

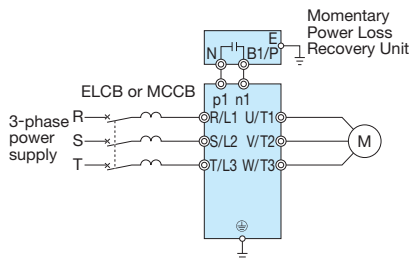

Dimensions (mm)

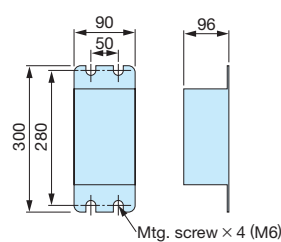

Model, Code No.

Model	Code No.
200 V Class: P0010	P0010
400 V Class: P0020	P0020

Note: Functions as a back-up power supply for drives up to 11 kW. Allows the drive to ride through a power loss up to 2 s long. The drive alone can continue running through a power loss lasting 0.1 s to 1.0 s. Results may vary with drive capacity.

LED Operator

Model	Code No.
JVOP-182	100-043-155

Dimensions (mm)

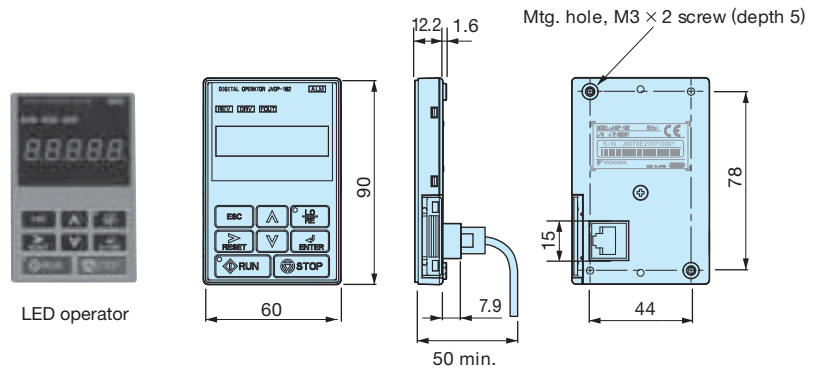

Operator Extension Cable

Enables remote operation

Model	Code No.
WV001 (1 m)	WV001
WV003 (3 m)	WV003

Note: Never use this cable for connecting the drive to a PC. Doing so may damage the PC.

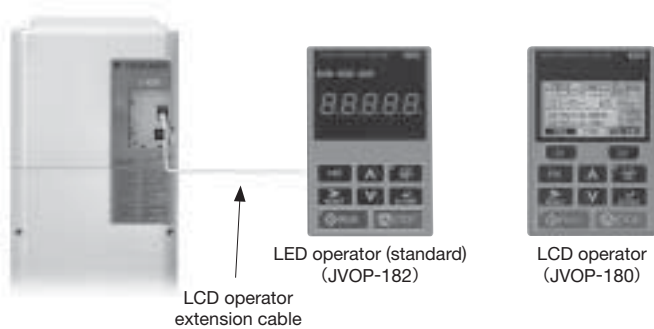

Operator Mounting Bracket

This bracket is required to mount the LED or LCD operator outside an enclosure panel.

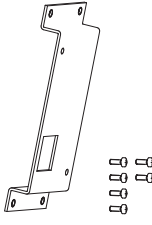
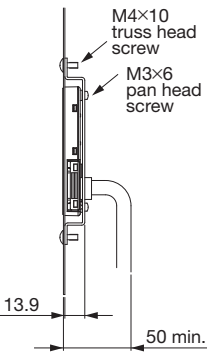
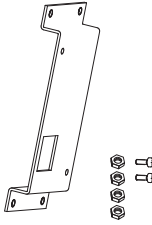
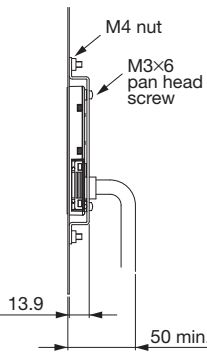
Item	Model	Code No.	Installation	Notes
 Installation Support Set A	EZZ020642A	100-039-992	 13.9 50 min.	For use with holes through the panel
 Installation Support Set B	EZZ020642B	100-039-993	 13.9 50 min.	For use with panel mounted threaded studs Note: If weld studs are on the back of the panel, use the Installation Support Set B.



● USB Copy Unit (Model: JVOP-181)

Copy parameter settings in a single step, then transfer those settings to another drive.
Connects to the RJ-45 port on the drive and to the USB port of a PC.

Connection

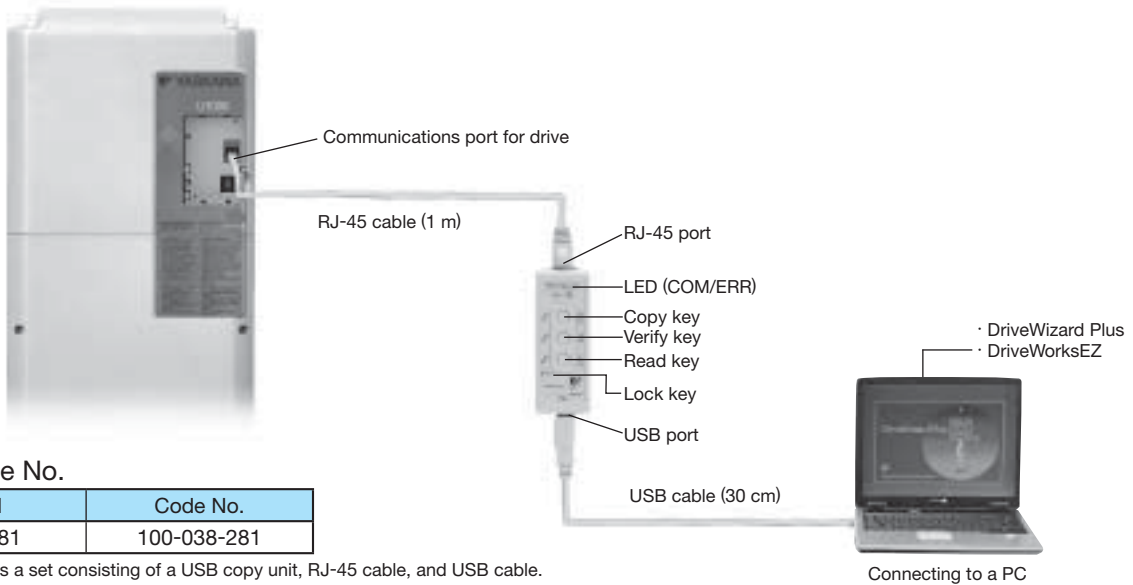

Model, Code No.

Model	Code No.
JVOP-181	100-038-281

Note: JVOP-181 is a set consisting of a USB copy unit, RJ-45 cable, and USB cable.

Specifications

Item	Specifications
Port	LAN (RJ-45) Connect to the drive.
	USB (Ver.2.0 compatible) Connect to the PC as required.
Power Supply	Supplied from a PC or the drive
Operating System	Windows2000/XP
Memory	Memorizes the parameters for one drive.
Dimensions	30 (W) × 80 (H) × 20 (D) mm
Accessories	RJ-45 Cable (1 m), USB Cable (30 cm)

Note: 1. Drives must have identical software versions to copy parameters settings.

2. Requires a USB driver.

You can download the driver for free from Yaskawa's product and technical information website (<http://www.e-mechatronics.com>).

3. Parameter copy function disabled when connected to a PC.

Note: 1. You can also use a commercially available USB 2.0 cable (with A-B connectors) for the USB cable.
2. No USB cable is needed to copy parameters to other drives.

● PC Cable

Cable to connect the drive to a PC with DriveWizard Plus or DriveWorksEZ installed.
Use a commercially available USB 2.0 cable (A-B connectors, max. 3 m).

Connection

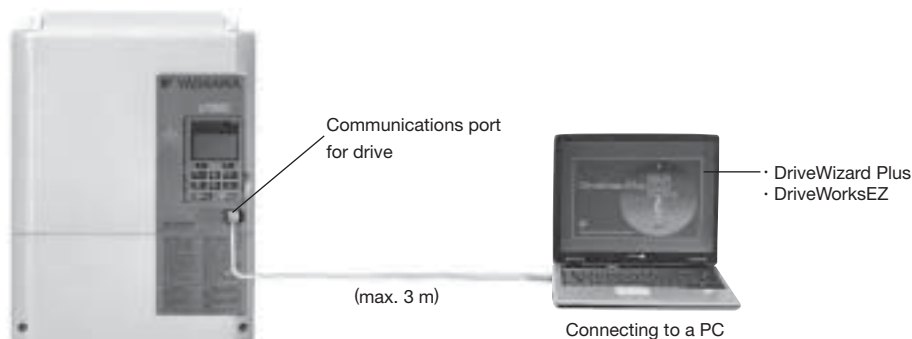

Note: You can also use the JVOP-181 copy unit and cables as the USB cable.

Note: 1. DriveWizard Plus is a PC software package for managing parameters and functions in Yaskawa drives. To order this software, contact your Yaskawa. DriveWorksEZ is the software for creating custom application programs for the drive through visual programming. To order this software, contact our sales representative.

2. Requires USB driver. You can download the driver for free from Yaskawa's product and technical information website (<http://www.e-mechatronics.com>).

Frequency Meter/Current Meter



Model, Code No.

Model	Code No.
Scale-75 Hz full-scale: DCF-6A	FM000065
Scale-60/120 Hz full-scale: DCF-6A	FM000085
Scale-5 A full-scale: DCF-6A	DCF-6A-5A
Scale-10 A full-scale: DCF-6A	DCF-6A-10A
Scale-20 A full-scale: DCF-6A	DCF-6A-20A
Scale-30 A full-scale: DCF-6A	DCF-6A-30A
Scale-50 A full-scale: DCF-6A	DCF-6A-50A

Note: DCF-6A specifications are 3 V, 1 mA, and 3 k Ω inner impedance. Because the U1000 multi-function analog monitor output default setting is 0 to 10 V, set frequency meter adjusting potentiometer (20 k Ω) or parameter H4-02 (analog monitor output gain) within the range of 0 to 3 V.

Dimensions (mm)

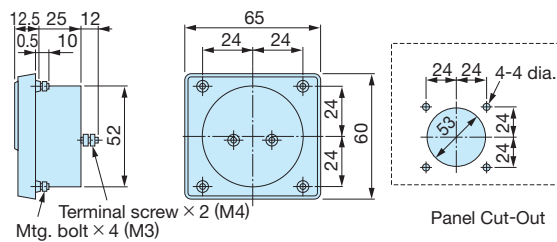

Variable Resistor Board (installed to drive terminals)



Model, Code No.

Model	Code No.
Meter scale 20 k Ω	ETX3120

Connection Diagram

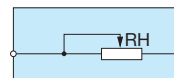

Weight: 20 g

Frequency Setting Potentiometer/Frequency Meter Adjusting Potentiometer

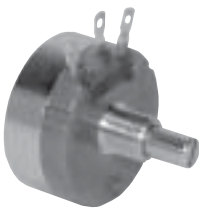

Model, Code No.

Model	Code No.
RV30YN20S 2 k Ω	RH000739
RV30YN20S 20 k Ω	RH000850

Dimensions (mm)

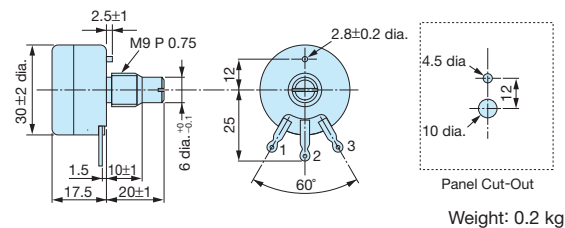

Control Dial for Frequency Setting Potentiometer/Frequency Meter Adjusting Potentiometer



Model, Code No.

Model	Code No.
CM-3S	HLNZ-0036

Dimensions (mm)

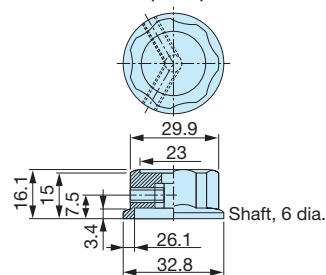

Meter Plate for Frequency Setting Potentiometer/Frequency Meter Adjusting Potentiometer



Model, Code No.

Model	Code No.
NPJT41561-1	NPJT41561-1

Dimensions (mm)

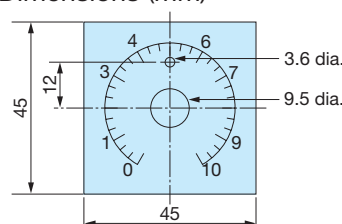



Output Voltage Meter



Model, Code No.

Model	Code No.
Scale-300 V full-scale (Rectification Type Class 2.5: SCF-12NH)	VM000481
Scale-600 V full-scale (Rectification Type Class 2.5: SCF-12NH)	VM000502

Dimensions (mm)

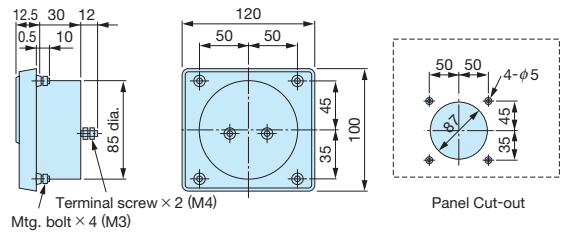

Weight: 0.3 kg

Potential Transformer

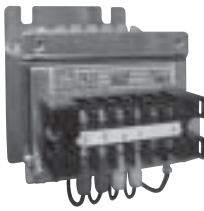

Model, Code No.

Model	Code No.
600 V meter for voltage transformer UPN-B 440/110 V (400/100 V)	100-011-486

Note: For use with a standard voltage regulator. A standard voltage regulator may not match the drive output voltage. Select a regulator specifically designed for the drive output (100-011-486), or a voltmeter that does not use a transformer and offers direct read out.

Dimensions (mm)

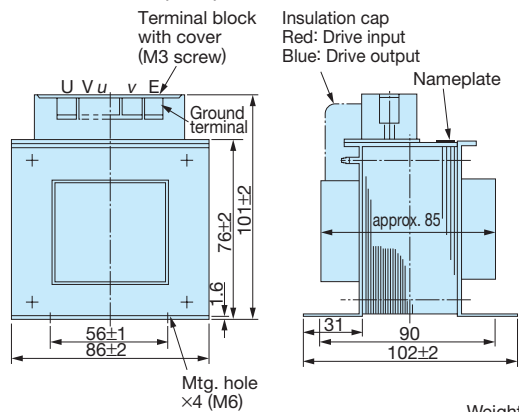

Weight: 2.2 kg

Features

Product Lineup

Model Selection

Parameter List

Basic Instructions

Standard Specifications

Standard Connection Diagram

Dimensions

Fully-Enclosed Design

Peripheral Devices and Options

Application Notes

Global Service Network

Application Notes

Selection

■ Rated Output Current Capacity

Make sure that the motor rated current is less than rated output current for the drive.

- When the harmonic current distortion rate is 5% or less

The rated output current of the drive should be larger than 1.15 times of the motor rated current. The default setting of C7-60 should be also changed. Refer to Technical Manual for details.

- When running more than one motor in parallel from a single drive

The capacity of the drive should be larger than 1.1 times of the total motor rated current. However, run only one motor from each drive when using vector control. It is not possible to run more than one motor from one drive with vector control.

■ When 2 Seconds is Required for Momentary Power Loss Ride-Thru Time

When continuing the drive operation after the power is restored even if a momentary loss of power of 2 seconds occurs, use the following units.

- 200 V class Momentary Power Loss Ride-Thru unit: Model no. 73600-P0010
- 400 V class Momentary Power Loss Ride-Thru unit: Model no. 73600-P0020

■ Required Time for Drive to be Ready

The drive needs 1.5 seconds* to prepare for operation after the power is turned on. Be careful of this delay if using an external reference input.

- * This time is required if no optional device is used with the drive. If an optional communication device is used, the time required for the drive to be ready for operation will vary in accordance with the start up time of the optional communication card.

■ Selection of Power Capacity

Use a power supply that is greater than the rated input capacity (kVA) of the drive. If the power is lower than the rated capacity of the drive, the device will be unable to run the application properly and a fault will occur.

The rated input capacity of the drive, S_{CONV} [kVA], can be calculated by the following formula.

$$S_{CONV} = \sqrt{3} \times I_{in} \times V_{in} \div 1000$$

(I_{in} : Rated input current [A], V_{in} : Applicable power line voltage [V])

■ Connection to Power Supply

The total impedance of the power supply and wiring for the rated current of the drive is $\%Z = 10\%$ or more. If the impedance of the power supply is too large, then power voltage distortion may occur. If the wiring is too long, then be sure that proper preventative measures such as thick cables or series wiring have been taken to lower the impedance of wiring. Contact Yaskawa or your Yaskawa agent for details.

■ Grounding the Power Supply

The drive is highly recommended that the power supply has its own dedicated ground because the drive is designed to run with a 1:1 ratio relative ratio relative to the power supply. Other devices should be grounded as directed in the specifications for those devices. Particular care needs to be taken when connecting sensitive electronic equipment (such as OA devices). Separate ground lines to prevent problems from noise, and install a noise filter.

■ When Using a Generator as a Power Supply

Select the generator capacity approximately twice as large as the drive input power supply capacity. For further information, contact your Yaskawa representative. Set the deceleration time or load so that the regenerative power from the motor will be 10% or less of the generator capacity.

■ When a Phase Advance Capacitor or Thyristor Controller is Provided for the Power Supply

No phase advance capacitor is needed for the drive. Installing a phase advance capacitor to the drive will weaken the power factor.

For the phase advance capacitor that has already been installed on the same power supply system as the drive, attach a phase-advance capacitor with a series reactor to prevent oscillation with the drive.

Contact Yaskawa or your Yaskawa agent, if any device generating voltage surge or voltage distortion such as DC motor drive thyristor controller or magnetic agitator is installed on the same power supply system.



- **Prevention Against EMC or Harmonic Leakage Current**
Use units with built-in EMC filters that have the CE marking.

If a device that will be affected by noise is near the drive, use a zero-phase reactor as a noise filter.

Use a leakage relay or a ground leakage breaker designed for products provided with prevention from harmonics leak current, when necessary.

- **Affects of Power Supply Distortion**
When the power supply voltage is distorted, the harmonics contents increase because the harmonics of the power supply system enter the drive.

- **Starting Torque**
The overload rating for the drive determines the starting and accelerating characteristics of the motor. Expect lower torque than when running from line power. To achieve a higher starting torque, use a larger drive, or a drive and motor with larger capacity.

- **Emergency Stop**
When the drive faults out, the output is shut off. This, however, does not stop the motor immediately. Some type of mechanical brake may be needed if it is necessary to halt the motor faster than the Fast Stop function is able to.

- **Repetitive Starting/Stopping**
Cranes (hoists), elevators, punching presses, and other such applications with frequent starts and stops often exceed 150% of their rated current values. Heat stress generated from repetitive high current can shorten the lifespan of the IGBTs. The expected lifespan for the IGBTs is about 8 million start and stop cycles with a 4 kHz carrier frequency and a 150% peak current.

For crane-type applications using an inching function in which the motor is quickly started and stopped, Yaskawa recommends selecting a large enough drive so that peak current levels remain below 150% of the drive rated current.

Run only one motor from each drive when using vector control. It is not possible to run more than one motor from one drive with vector control.

- **Carrier Frequency Derating**
When the carrier frequency of the drive is increased above the factory default setting, the rated output current of the drive should be reduced. Refer to the instruction manual of the drive for details on this function.

Installation

- **Enclosure Panels**
Keep the drive in a clean environment by either selecting an area free of airborne dust, lint, and oil mist, or install the drive in an enclosure panel. Leave the required space between the drives to provide for cooling, and take steps to ensure that the ambient temperature remains within allowable limits. Keep flammable materials away from the drive. If the drive must be used in an area where it is subjected to oil mist and excessive vibration, protective designs are available. Contact Yaskawa or your Yaskawa agent for details.

- **Installation Direction**
The drive should be installed upright as specified in the manual.

Settings

- **Motor Code**
If using permanent magnet motors, make sure that the proper motor code has been set to parameter E5-01 before performing a trial run.

- **Upper Limits**
The drive is capable of running the motor up to 400 Hz. Due to the danger of accidentally operating at high speed, be sure to set the upper limit for the frequency to control the maximum speed. The default setting for the maximum output frequency is 60 Hz.

- **DC Injection Braking**
Motor overheat can result if there is too much current used during DC Injection Braking, or if the time for DC Injection Braking is too long.

- **Acceleration/Deceleration Times**
Acceleration and deceleration times are affected by how much torque the motor generates, the load torque, and the inertia moment. Set a longer accel/decel time when Stall Prevention is enabled. The accel/decel times are lengthened for as long as the Stall Prevention function is operating. For faster acceleration and deceleration, use a larger drive and motor.

Features

Product Lineup

Model Selection

Parameter List

Basic Instructions

Standard Specifications

Standard Connection Diagram

Dimensions

Fully-Enclosed Design

Peripheral Devices and Options

Application Notes

Global Service Network

Compliance with Harmonic Suppression Guidelines

- Guidelines for harmonic suppression measures are applicable to consumers that receive power from a 6.6 kV or higher system. For details, refer to the Harmonics Suppression Technical Guideline JEAG 9702-1995.
- With respect to the harmonic suppression guidelines, the U1000 is a Matrix Converter and does not generate harmonics ($K_s=0$). However, the harmonic component is not completely zero.

General Handling

■ Wiring Check

Doing so will destroy the drive.

Be sure to perform a final check of all sequence wiring and other connections before turning the power on. Make sure there are no short circuits on the control terminals (+V, AC, etc.), as this could damage the drive.

■ Installing a Ground Fault Interrupter or an MCCB

We recommend that you install ground fault interrupter (ELCB) for wire protection and as protection against secondary damage for faults. Also, if short circuit cutoffs are permitted in the upstream power supply system, we recommend that you use a molded case circuit breaker (MCCB).

We recommend that you select an ELCB designed for AC drives (one with high-frequency countermeasures).

Select the MCCB based on the power supply power factor of the Matrix Converter (depends on the power supply voltage, output frequency, and load).

■ Magnetic Contactor Installation

Use a magnetic contactor (MC) to ensure that power to the drive can be completely shut off when necessary. The MC should be wired so that it opens when a fault output terminal is triggered.

Avoid switching a magnetic contactor on the power supply side more frequently than once every 30 minutes. Frequent switching can cause damage to the drive.

■ Inspection and Maintenance

Capacitors for the control power supply take time to discharge even after the power has been shut off. After shutting off the power, wait for at least the amount of time specified on the drive before touching any components.

The heatsink can become quite hot during operation, and proper precautions should be taken to prevent burns. When replacing the cooling fan, shut off the power and wait at least 15 minutes to be sure that the heatsink has cooled down.

Even when the power has been shut off for a drive running a PM motor, voltage continues to be generated at the motor terminals while the motor coasts to stop. Take the precautions described below to prevent shock and injury:

- Applications where the machine can still rotate even though the drive has fully stopped should have a load switch installed to the output side of the drive. Yaskawa recommends manual load switches from the AICUT LB Series by AICHI Electric Works Co., Ltd.
- Do not allow an external force to rotate the motor beyond the maximum allowable speed, also when the drive has been shut off.
- Wait for at least the time specified on the warning label after opening the load switch on the output side before inspecting the drive or performing any maintenance.
- Do not open and close the load switch while the motor is running, as this can damage the drive.
- If the motor is coasting, make sure the power to the drive is turned on and the drive output has completely stopped before closing the load switch.

■ Wiring

All wire ends should use ring terminals for UL/cUL compliance. Use only the tools recommended by the terminal manufacturer for crimping.

■ Transporting the Drive

Never steam clean the drive.

During transport, keep the drive from coming into contact with salts, fluorine, bromine, phthalate ester, and other such harmful chemicals.



Notes on Motor Operation

Using a Standard Motor

Low Speed Range

There is a greater amount of loss when operating a motor using a drive than when running directly from line power. With a drive, the motor can become quite hot due to the poor ability to cool the motor at low speeds. The load torque should be reduced accordingly at low speeds. The figure above shows the allowable load characteristics for a Yaskawa standard motor. A motor designed specifically for operation with a drive should be used when 100% continuous torque is needed at low speeds.

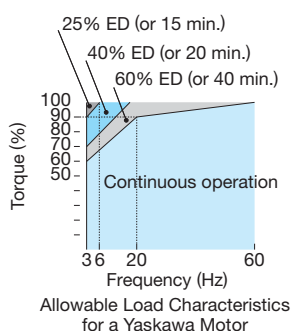

Insulation Tolerance

Consider voltage tolerance levels and insulation in applications with an input voltage of over 440 V or particularly long wiring distances. Contact Yaskawa or your Yaskawa agent for consultation.

High Speed Operation

Problems may occur with the motor bearings and dynamic balance in applications operating at over 60 Hz. Contact Yaskawa for consultation.

Torque Characteristics

Torque characteristics differ when operating directly from line power. The user should have a full understanding of the load torque characteristics for the application.

Vibration and Shock

U1000 lets the user choose high carrier PWM control. Selecting Closed Loop Vector Control can help reduce motor oscillation. Keep the following points in mind when using high carrier PWM:

(1) Resonance

Take particular caution when using a variable speed drive for an application that is conventionally run from line power at a constant speed. Shock-absorbing rubber should be installed around the base of the motor and the Jump Frequency selection should be enabled to prevent resonance.

(2) Any imperfection on a rotating body increases vibration with speed.

Caution should be taken when operating above the motor rated speed.

(3) Subsynchronous Resonance

Subsynchronous resonance may occur in fans, blowers, turbines, and other applications with high load inertia, as well as in motors with a relatively long shaft.

Audible Noise

Noise created during run varies by the carrier frequency setting. Using a high carrier frequency creates about as much noise as running from line power. Operating above the rated speed can create unpleasant motor noise.

Using a Synchronous Motor

- Yaskawa or your Yaskawa agent if you plan to use any other synchronous motor not endorsed by Yaskawa.
- A single drive is not capable of running multiple synchronous motors at the same time. Use a standard induction motor for such setups.
- At start, a synchronous motor may rotate slightly in the opposite direction of the Run command depending on parameter settings and motor type.
- The amount of starting torque that can be generated differs by each control mode and by the type of motor being used. Set up the motor with the drive after verifying the starting torque, allowable load characteristics, impact load tolerance, and speed control range. Contact Yaskawa or your Yaskawa agent if you plan to use a motor that does not fall within these specifications.
- Even with a braking resistor, braking torque is less than 125% when running between 20% to 100% speed, and falls to less than half the braking torque when running at less than 20% speed.
- In Open Loop Vector Control for PM motors, the allowable load inertia moment is approximately 50 times higher than the motor inertia moment or less. Contact Yaskawa or your Yaskawa agent concerning applications with a larger inertia moment.
- When using a holding brake in Open Loop Vector Control for PM motors, release the brake prior to starting the motor. Failure to set the proper timing can result in speed loss. Not for use with conveyor, transport, or hoist type applications.
- To restart a coasting motor rotating at over 200 Hz while in the V/f control mode, Speed Search can be used.

Features

Product Lineup

Model Selection

Parameter List

Basic Instructions

Standard Specifications

Standard Connection Diagram

Dimensions

Fully-Enclosed Design

Peripheral Devices and Options

Application Notes

Global Service Network

● Applications with Specialized Motors

■ Multi-Pole Motor

Because the rated current will differ from a standard motor, be sure to check the maximum current when selecting a drive. Always stop the motor before switching between the number of motor poles. If a regenerative overvoltage fault occurs or if overcurrent protection is triggered, the motor will coast to stop.

■ Submersible Motor

Because motor rated current is greater than a standard motor, select the drive capacity accordingly. Be sure to use a large enough motor cable to avoid decreasing the maximum torque level on account of voltage drop caused by a long motor cable.

■ Explosion-Proof Motor

Both the motor and drive need to be tested together to be certified as explosion-proof. The drive is not for explosion proof areas.

An explosion-proof pulse generators (PG) is used for an explosion-proof with voltage tolerance. Use a specially designed pulse coupler between the drive and the PG when wiring.

■ Geared Motor

Continuous operation specifications differ by the manufacturer of the lubricant. Due to potential problems of gear damage when operating at low speeds, be sure to select the proper lubricant. Consult with the manufacturer for applications that require speeds greater than the rated speed range of the motor or gear box.

■ Single-Phase Motor

Variable speed drives are not designed for operating single phase motors. Using a capacitor to start the motor causes excessive current to flow into the capacitors, potentially causing damage. A split-phase start or a repulsion start can end up burning out the starter coils because the internal centrifugal switch is not activated. U1000 is for use only with 3-phase motors.

■ Motor with Brake

Caution should be taken when using a drive to operate a motor with a built-in holding brake. If the brake is connected to the output side of the drive, it may not release at start due to low voltage levels. A separate power supply should be installed for the motor brake. Motors with a built-in brake tend to generate a fair amount of noise when running at low speeds.

Power Driven Machinery (decelerators, belts, chains, etc.)

Continuous operation at low speeds wears on the lubricating material used in gear box type systems to accelerate and decelerate power driven machinery. Caution should also be taken when operating at speeds above the rated machine speed due to noise and shortened performance life.



Global Service Network



Region	Service Area	Service Location	Service Agency	Telephone/Fax
North America	U.S.A.	Chicago (HQ) Los Angeles San Francisco New Jersey Boston Ohio North Carolina	① YASKAWA AMERICA INC.	Headquarters ☎ +1-847-887-7000 FAX +1-847-887-7310
	Mexico	Mexico City	② PILLAR MEXICANA. S.A. DE C.V.	☎ +52-555-660-5553 FAX +52-555-651-5573
South America	South America	São Paulo	③ YASKAWA ELÉTRICO DO BRASIL LTDA.	☎ +55-11-3585-1100 FAX +55-11-5581-8795
	Colombia	Bogota	④ VARIADORES LTD.A.	☎ +57-1-428-4225 FAX +57-1-428-2173
Europe	Europe, South Africa	Frankfurt	⑤ YASKAWA EUROPE GmbH	☎ +49-6196-569-300 FAX +49-6196-569-398
Asia	Japan	Tokyo, offices nationwide	⑥ YASKAWA ELECTRIC CORPORATION (Manufacturing, sales)	☎ +81-3-5402-4502 FAX +81-3-5402-4580
			⑦ YASKAWA ELECTRIC ENGINEERING CORPORATION (After-sales service)	☎ +81-4-2931-1810 FAX +81-4-2931-1811
	South Korea	Seoul	⑧ YASKAWA ELECTRIC KOREA CORPORATION	☎ +82-2-784-7844 FAX +82-2-784-8495
			⑨ YASKAWA ENGINEERING KOREA CORPORATION	☎ +82-2-3775-0337 FAX +82-2-3775-0338
	China	Beijing, Guangzhou, Shanghai	⑩ YASKAWA ELECTRIC (CHINA) CO., LTD.	☎ +86-21-5385-2200 FAX +86-21-5385-3299
	Taiwan	Taipei	⑪ YASKAWA ELECTRIC TAIWAN CORPORATION	☎ +886-2-2502-5003 FAX +886-2-2505-1280
	Singapore	Singapore	⑫ YASKAWA ELECTRIC (SINGAPORE) PTE. LTD.	☎ +65-6282-3003 FAX +65-6289-3003
			⑬ YASKAWA ENGINEERING ASIA-PACIFIC PTE. LTD.	☎ +65-6282-1601 FAX +65-6382-3668
	Thailand	Bangkok	⑭ YASKAWA ELECTRIC (THAILAND) CO., LTD.	☎ +66-2693-2200 FAX +66-2693-4200
	India	Mumbai	⑮ LARSEN & TOUBRO LIMITED	Headquarters ☎ +91-22-67226200 +91-22-27782230 FAX +91-22-27783032
⑯ PT. YASKAWA ELECTRIC INDONESIA			☎ +62-21-5794-1845 FAX +62-21-5794-1843	
Indonesia	Jakarta			
Oceania	Australia	Sydney (HQ) Melbourne	⑰ ROBOTIC AUTOMATION PTY. LTD.	Headquarters ☎ +61-2-9748-3788 FAX +61-2-9748-3817

- Features
- Product Lineup
- Model Selection
- Parameter List
- Basic Instructions
- Standard Specifications
- Standard Connection Diagram
- Dimensions
- Fully-Enclosed Design
- Peripheral Devices and Options
- Application Notes
- Global Service Network

U1000

DRIVE CENTER (INVERTER PLANT)

2-13-1, Nishimiyaichi, Yukuhashi, Fukuoka, 824-8511, Japan
Phone 81-930-25-3844 Fax 81-930-25-4369
<http://www.yaskawa.co.jp>

YASKAWA ELECTRIC CORPORATION

New Pier Takeshiba South Tower, 1-16-1, Kaigan, Minatoku, Tokyo, 105-6891, Japan
Phone 81-3-5402-4502 Fax 81-3-5402-4580
<http://www.yaskawa.co.jp>

YASKAWA AMERICA, INC.

2121 Norman Drive South, Waukegan, IL 60085, U.S.A.
Phone 1-800-YASKAWA (927-5292) or 1-847-887-7000 Fax 1-847-887-7310
<http://www.yaskawa.com>

YASKAWA ELÉTRICO DO BRASIL LTDA.

Avenida Piraporinha 777, Diadema, São Paulo, 09950-000, Brazil
Phone 55-11-3585-1100 Fax 55-11-3585-1187
<http://www.yaskawa.com.br>

YASKAWA EUROPE GmbH

Hauptstrasse 185, 65760 Eschborn, Germany
Phone 49-6196-569-300 Fax 49-6196-569-398
<http://www.yaskawa.eu.com>

YASKAWA ELECTRIC KOREA CORPORATION

9F, Kyobo Securities Bldg., 26-4, Yeouido-dong, Yeongdeungpo-gu, Seoul, 150-737, Korea
Phone 82-2-784-7844 Fax 82-2-784-8495
<http://www.yaskawa.co.kr>

YASKAWA ELECTRIC (SINGAPORE) PTE. LTD.

151 Lorong Chuan, #04-02A, New Tech Park 556741, Singapore
Phone 65-6282-3003 Fax 65-6289-3003
<http://www.yaskawa.com.sg>

YASKAWA ELECTRIC (CHINA) CO., LTD.

12F, Carlton Bldg., No.21 HuangHe Road, HuangPu District, Shanghai 200003, China
Phone 86-21-5385-2200 Fax 86-21-5385-3299
<http://www.yaskawa.com.cn>

YASKAWA ELECTRIC (CHINA) CO., LTD. BEIJING OFFICE

Room 1011, Tower W3 Oriental Plaza, No.1 East Chang An Ave.,
Dong Cheng District, Beijing, 100738, China
Phone 86-10-8518-4086 Fax 86-10-8518-4082

YASKAWA ELECTRIC TAIWAN CORPORATION

9F, 16, Nanking E. Rd., Sec. 3, Taipei, 104, Taiwan
Phone 886-2-2502-5003 Fax 886-2-2505-1280
<http://www.yaskawa-taiwan.com.tw>

YASKAWA INDIA PRIVATE LIMITED

#17/A Electronics City, Hosur Road Bangalore 560 100 (Karnataka), India
Phone 91-80-4244-1900 Fax 91-80-4244-1901
<http://www.yaskawaindia.in>



YASKAWA ELECTRIC CORPORATION

In the event that the end user of this product is to be the military and said product is to be employed in any weapons systems or the manufacture thereof, the export will fall under the relevant regulations as stipulated in the Foreign Exchange and Foreign Trade Regulations. Therefore, be sure to follow all procedures and submit all relevant documentation according to any and all rules, regulations and laws that may apply. Specifications are subject to change without notice for ongoing product modifications and improvements.
© XXXX YASKAWA ELECTRIC CORPORATION. All rights reserved.

LITERATURE NO. KAEP C710636 02A
Published in Japan June 2014 14-06
14-5-13